

FORD CODE READER

OWNER'S MANUAL

For Ford, Lincoln,
Mercury 1981 to
1995 Domestic
cars and Trucks

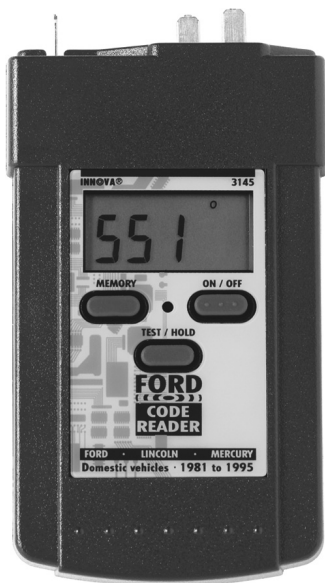

Table of Contents

Title	Page No.
YOU CAN DO IT!	ii
CHAPTER 1 - GENERAL INFORMATION	
SAFETY PRECAUTIONS	1
INTRODUCTION	2
HOW TO USE THIS MANUAL	2
VEHICLE SERVICE MANUALS	3
VEHICLES COVERED	4
PRELIMINARY VEHICLE DIAGNOSIS WORKSHEET	8
CHAPTER 2 - ABOUT DIAGNOSTIC SYSTEMS	
WHAT ARE THE ADVANTAGES OF USING COMPUTER CONTROL SYSTEMS ON VEHICLES?	11
HOW DOES A COMPUTER SYSTEM WORK ON A VEHICLE, AND WHAT IS IT'S MAIN PURPOSE?	11
HISTORY OF FORDS ELECTRONIC ENGINE CONTROL (EEC) SYSTEMS	13
FORD COMPUTER SYSTEM OVERVIEW	14
CHAPTER 3 - ABOUT THE FORD CODE READER	
BEFORE YOU BEGIN	17
TEST CONNECTORS	18
CONNECTING THE FORD CODE READER TO THE VEHICLE'S TEST CONNECTOR(S)	18
FUNCTIONS OF THE FORD CODE READER	19
CHAPTER 4 - RETRIEVING CODES	
OVERVIEW OF FAULT CODES	23
OVERVIEW OF FORD CODE RETRIEVAL PROCESS	24
KEY ON ENGINE OFF (KOEO) TEST PROCEDURES (EEC-IV SYSTEMS)	25
ENGINE TIMING CHECK (EEC-IV SYSTEMS)	30
KEY ON ENGINE RUNNING (KOER) SELF TEST (EEC-IV SYSTEMS)	32
ERASING CODES FROM EEC-IV SYSTEMS	37
ADDITIONAL TESTS FOR EEC-IV SYSTEMS	38
FAULT CODE DEFINITIONS FOR EEC-IV SYSTEMS CAR AND TRUCK	46
RETRIEVING FAULT CODES FROM MCU SYSTEMS	65
KEY ON ENGINE OFF (KOEO) SELF TEST (MCU SYSTEMS)	66
KEY ON ENGINE RUNNING (KOER) SELF TEST (MCU SYSTEMS)	68
FAULT CODE DEFINITIONS FOR MCU SYSTEMS CAR AND TRUCK	71
CHAPTER 5 - TROUBLESHOOTING	
CODE READER TROUBLESHOOTING GUIDE	75
CHAPTER 6 - GLOSSARY	
INTRODUCTION	77
GLOSSARY OF TERMS AND ABBREVIATIONS	77
CHAPTER 7 - WARRANTY AND SERVICE	
LIMITED ONE YEAR WARRANTY	89
SERVICE PROCEDURES	89

SAFETY PRECAUTIONS

To avoid personal injury, instrument damage and/or damage to equipment under test; do not operate the Ford Digital Code Reader before reading this manual.

This manual describes common test procedures used by experienced service personnel and technicians. Many test procedures require precautions to avoid accidents that can result in personal injury, and/or vehicle or equipment damage. Always read your vehicle's service manual and follow its safety precautions before any test or service procedure is performed.

- a. When an engine is running, it produces carbon monoxide (a toxic and poisonous gas). To prevent serious injury or death from carbon monoxide poisoning, operate a vehicle **ONLY** in a **well-ventilated** area.
- b. To protect your eyes from propelled objects as well as hot or caustic liquids, **always** wear **approved** safety eye protection.
- c. When an engine is running, several objects rotate at a very high rate of speed (cooling fan, pulleys, fan belt etc.). To avoid serious injury, always be conscious of moving parts, and keep a safe distance from all these items as well as other potentially moving objects.
- d. Engine parts become extremely hot when the engine is running. To prevent severe burns, avoid contact with hot engine parts.
- e. Before starting an engine for troubleshooting, make sure the parking brake is engaged. Put the transmission in "park" (for automatic transmission) or "neutral" (for manual transmission). Block the drive wheels with a suitable blocking device.
- f. Connecting or disconnecting test equipment when the ignition is "on" can cause a spark. This spark is potentially damaging to the test equipment and to the vehicle's electronic components. Always turn the ignition "off" before connecting or disconnecting any test equipment.
- g. To prevent damage to the on-board computer when taking vehicle electrical measurements, always use a digital multimeter with at least 10 Megohms of impedance.

- h. The vehicle's battery produces highly flammable hydrogen gas. To prevent an explosion, keep all sparks, high temperature items or open flames away from the battery.
- i. Don't wear loose clothing or jewelry when working on an engine. Loose clothing can get caught on the fan, pulleys, belts, etc. Jewelry is highly conductive, and can cause a severe burn if it makes contact between a power source and ground.

INTRODUCTION

Congratulations, you have purchased one of the most technologically advanced Code Readers on the market today. The Ford Digital Code Reader uses sophisticated electronics designed to retrieve engine and transmission (applicable Ford vehicles only) Diagnostic Trouble Codes (DTC's) from the vehicle's computer.

HOW TO USE THIS MANUAL

This Code Reader and manual are designed for use both by consumers with little or no experience in retrieving codes, or by experienced technicians desiring a more in-depth explanation of Ford Computer Command Control system basics.

If you are having problems with your vehicle and only want to know if any Diagnostic Trouble Codes are present in the vehicle's computer system, read the "Safety Precautions" (page 1) and "Vehicles Covered" (page 4), then proceed to Chapter 3 and follow the simple directions to retrieve the codes. The codes retrieved, and their definitions, will give you valuable information and a starting point from which to proceed to the next step.

Once the codes have been retrieved, you can choose to:

- **Take your vehicle to an Automotive Service Center for repair:** Take your vehicle, a copy of the completed Preliminary Vehicle Diagnosis Worksheet (see pages 8 - 10) and codes retrieved to your technician for evaluation. This will demonstrate to your technician that you are an informed motorist and will also assist him in pinpointing the location of the problem.

- **Attempt to fix the problem yourself:** If you choose to fix the problem yourself, **read** and follow all of the manual's recommendations and procedures. Additional tools, test equipment (multimeter, timing light, etc.) and a vehicle repair manual containing Ford's Diagnostic Trouble Code Service Procedures for your vehicle will be needed.

VEHICLE SERVICE MANUALS

It is recommended that you consult the manufacturer's service manual for your vehicle before any test or repair procedures are performed.

Contact your local car dealership, auto parts store or bookstore for availability of these manuals. The following companies publish valuable repair manuals:

■ **Haynes Publications**

861 Lawrence Drive, Newbury Park, California 91320
Phone: 800-442-9637

■ **Mitchell International**

14145 Danielson Street, Poway, California 92064
Phone: 888-724-6742

■ **Motor Publications**

5600 Crooks Road, Suite 200, Troy, Michigan 48098
Phone: 800-426-6867

FACTORY SOURCES

Ford, GM, Chrysler, Honda, Isuzu

Hyundai and Subaru Service Manuals

■ **Helm Inc.**

14310 Hamilton Avenue, Highland Park, Michigan 48203
Phone: 800-782-4356

VEHICLES COVERED
CAR - Ford, Lincoln, Mercury Computer System/Code Reader Application Table

The following table is applicable to all models (excluding Diesel) of Ford, Lincoln and Mercury vehicles.

Engine	8th VIN Digit**	Fuel Systems (Carburetor Model)	Application/Special Notes	Computer System
1981-1982				
2.3L I-4 OHC	A	FBC (6500-2V)*	Capri, Cougar, Fairmont, Granada, Mustang, Zephyr	MCU
3.8L V-6	3	FBC (7200 VV-2V)*	Continental, Cougar, Granada, T-Bird (Cal. only)	
4.2L V-8	D		Capri, Cougar, Fairmont, Granada, Mark VII, Mustang, T-Bird, Zephyr	
5.0L V-8	F		Capri, Continental (Cal. only), Granada, Mark VII, Mustang	
5.8L V-8	G		All Federal Police models	
1983				
2.3L I-4 OHC	A	FBC (6500-2V)*	Capri, Fairmont, LTD, Marquis, Mustang	MCU
3.8L V-6	3	FBC (7200-VV-2V)*	Continental, Cougar, Granada, T-Bird (Cal. only)	
5.0L V-8	F		Capri, Continental, Cougar, Fairmont, Granada, Mark VII, Mustang, T-Bird, Zephyr	
5.8L V-8	G			
1.6L I-4	5, 2	EFI, EFI Turbo	Escort, EXP, LN7, Lynx	EEC-IV
2.3L I-4	5	EFI Turbo	Capri, Cougar, Mustang, T-Bird	
2.3L I-4 HSC	R, J	FBC (6149)*	Capri, Fairmont, LTD, Marquis, Mustang, Tempo, Topaz, Zephyr	
1984-1986				
5.8L V-8	G	FBC (7200-VV-2V)*	Crown Victoria, Grand Marquis	MCU
1.6L I-4	4, 5 8	EFI EFI Turbo	Escort, EXP, Lynx	EEC-IV
2.3L I-4 2.3L I-4 OHC	A, J, R	FBC (YFA)* (6149)*	Capri, Cougar, LTD, Marquis, Mustang, Tempo, Topaz	
2.3L I-4	T, W	EFI Turbo	Capri, Cougar, Merkur XR4Ti, Mustang, T-Bird	
2.3L I-4 HSC	S, X	CFI	Tempo, Topaz	
3.8L V-6	3	CFI	Capri, Cougar, LTD, Marquis, Mustang, T-Bird	
5.0L V-8	F, M	CFI, SEFI	Capri, Continental, Colony Park, Cougar, Country Squire, Crown Victoria, Grand Marquis, LTD, Mark VII, Marquis, Mustang, T-Bird, Town Car	

Engine	8th VIN Digit**	Fuel Systems (Carburetor Model)	Application/Special Notes	Computer System
1987-1993				
5.8L V-8	G	FBC (7200 VV-2V)*	1987-91 Police vehicles only (carbureted)	MCU
1.9L I-4	J, 9	EFI, CFI, SFI	Escort, EXP, Lynx, Tracer	EEC-IV
2.0L I-4	A	SEFI	Probe (1993 manual transmission only)	
2.3L I-4	A	FBC (YFA)*	Capri, LTD, Marquis, Mustang (1996 models)	
2.3L I-4 OHC	A, M	EFI	Mustang	
2.3L I-4	T, W	EFI Turbo	Capri, Cougar, Merkur, Mustang, T-Bird, XR4Ti	
2.3L I-4 HSC	S, X	CFI, EFI, SEFI	Tempo, Topaz	
2.5L I-4	D	EFI, CFI	Sable, Taurus	
3.0L V-6 3.0L V-6 SHO	1, U, Y	EFI, SEFI, SFI	Probe, Sable, Taurus, Tempo, Topaz (VIN 1 Taurus models are Flexible Fuel)	
3.8L V-6	3, 4, C, R	CFI, EFI, SFI	Capri, Continental, Cougar, LTD, Marquis, Mustang, Sable, T-Bird, Taurus	
4.6L V-8	W, V	SEFI	Crown Victoria, Grand Marquis, Mark VII, Town Car	
5.0L V-8	F, M, E, T, D, 4	SEFI	Capri, Continental, Cougar, Crown Victoria, Grand Marquis, Mark VII, Mustang, Mustang Cobra, T-Bird, Town Car	
1994				
1.9L I-4	J	SFI	Escort, Topaz, Tracer	EEC-IV
2.0L I-4	A	SFI	Probe	
3.0L V-6	1, U, Y	SFI	Sable, Taurus, Tempo (VIN 1 Taurus models are Flexible Fuel)	
3.8L V-6 3.8L V-6 SC	4 R	SFI	Continental, Cougar, Sable, Taurus, T-Bird	
4.6L V-8	W, V	SFI	Crown Victoria, Grand Marquis, Mark VIII, Town Car	
5.0L V-8	T, D	SFI	Mustang, Mustang Cobra	
1995				
1.9L I-4	J	SFI	Escort, Tracer	EEC-IV
2.0L I-4	A, 3	SFI	Contour, Mystique, Probe	
2.5L V-6	L	SFI	Contour, Mystique	
3.0L V-6	1, U	SFI	Sable, Taurus (VIN 1 Taurus models are Flexible Fuel)	
3.0L V-6 SHO	Y			
3.8L V-6	4	SFI	Cougar, Sable, Taurus, T-Bird	
3.8L V-6 SC	R			
4.6L V8 DOHC	V	SFI	Mark VIII	
5.0L V-8 HO	T	SFI	Mustang	
5.0L V-8 SHP	D			

NOTES
* Carburetor Model. Carburetor model numbers are usually stamped on top of the carburetor, or on a metal tab attached to the carburetor. Consult your vehicle's repair manual for proper identification.
** VIN Number. The VIN number(s) used in this column identify the vehicle's engine type. This number is the 8th digit of the VIN (Vehicle Identification Number). Consult your vehicle's repair manual for details.
Application Table Definitions. CFI = Central Fuel Injection; DOHC = Dual Overhead Cam; EFI = Electronic Fuel Injection; FBC = Feedback Carburetor; HSC = High Swirl Combustion; MFI = Multiport Fuel Injection; OHC = Overhead Cam; SC = Super Charged; SEFI = Sequential Electronic Fuel Injection; SFI = Sequential Fuel Injection; SHO = Super High Output

TRUCKS/VANS - Ford Computer System Code Reader Application Table

The following table is applicable to all models of Trucks, Vans and Utility Vehicles.

Engine	8th VIN Digit**	Fuel Systems (Carburetor Model)	Application/Special Notes	Computer System
1981-1982				
4.9L I-6	E	FBC (YFA)*	Bronco (Cal. only); E and F Series Trucks/Vans	MCU
1983				
2.0L I-4	C	FBC (2150A)*	Ranger Pickup	MCU
2.3L I-4 OHC	A	FBC (YFA)*	Ranger Pickup (excluding high altitude)	
4.9L I-6	E	FBC (YFA)*	Bronco (Cal. only), E and F Series Trucks/Vans (8500 lb. GVW or less only)	
2.8L V-6	S	FBC (2150A)*	Bronco II and Ranger Pickup	EEC-IV
1984				
2.0L I-4	C	FBC (YFA)*	Ranger Pickup	MCU
2.3L I-4 OHC	A	FBC (YFA)*		
2.8L V-6	S	FBC (2150A)*	Bronco II, Ranger Pickup	EEC-IV
4.9L I-6	Y	FBC (YFA)*	Bronco, E and F Series Trucks/Vans (8500 lb. GVW or less only)	
5.0L V-8	F	FBC (2150A)*		
5.8L V-8	G	FBC (2150A)*		
1985-1990				
2.3L I-4 OHC	A	EFI	Aerostar, Bronco II, Ranger (excluding Diesel)	EEC-IV
2.9L V-6	T	EFI		
2.8L V-6	S	FBC (2150A)*	Bronco, E and F Series Trucks/Vans (8500 lb. GVW or less only)	
4.9L I-6	Y, 9	FBC (YFA)*, EFI		
5.0L V-8	F	FBC (2150A)*		
5.0L V-8	N	EFI		

Engine	8th VIN Digit**	Fuel Systems (Carburetor Model)	Application/Special Notes	Computer System
1985-1990 (Cont)				
5.8L V-8	G	FBC (2150A)*	E and F Series Trucks/Vans (8500 lb. GVW or less only)	EEC-IV
7.3L V-8	M	Diesel		
7.5L V-8	G	EFI		
1991-1994				
2.3L I-4 OHC	A	EFI, MFI	Ranger	EEC-IV
2.9L V-6	T	EFI		
3.0L V-6	U	EFI, SEFI, SFI	Aerostar, Ranger	
4.0L V-6	X	EFI, MFI	Aerostar, Explorer, Ranger	
4.9L I-6	Y, H	EFI, MFI, SFI	Bronco, E and F Series Trucks/Vans (8500 lb. GVW or less only)	
5.0L V-8	N	EFI, MFI, SFI		
5.8L V-8	H, R	EFI, MFI, SFI		
7.3L V-8	M	Diesel	E and F Series Trucks/Vans (Excludes 1994 diesel models)	
7.3L V-8	K	Turbo Diesel		
7.5L V-8	G	EFI, MFI		
1995				
3.0L V-6	U	SFI	Aerostar (Excludes Explorer, Ranger and Windstar)	EEC-IV
4.0L V-6	X	SFI		
4.9L I-6	Y	SFI	E and F series Trucks and Vans (Excludes Natural Gas equipped vehicles)	
5.0L V-8	N	SFI	Bronco, E and F series Trucks and Vans	
5.8L V-8	H, R	MFI		
7.5L V-8	G	MFI	E-350; F-250-350 (Excludes California); F-Super Duty (Excludes Diesel)	
NOTES				
* Carburetor Model. Carburetor model numbers are usually stamped on top of the carburetor, or on a metal tab attached to the carburetor. Consult your vehicle's repair manual for proper identification.				
** VIN Number. The VIN number(s) used in this column identify the vehicle's engine type. This number is the 8th digit of the VIN (Vehicle Identification Number). Consult your vehicle's repair manual for details.				
Application Table Definitions. EFI = Electronic Fuel Injection; FBC = Feedback Carburetor; MFI = Multiport Fuel Injection; OHC = Overhead Cam; SC = Super Charged; SEFI = Sequential Electronic Fuel Injection; SFI = Sequential Fuel Injection				

PRELIMINARY VEHICLE DIAGNOSIS WORKSHEET

The purpose of this form is to help you gather preliminary information on your vehicle before you retrieve codes. By having a complete account of your vehicle's current problem(s), you will be able to systematically pinpoint the problem(s) by comparing your answers to the fault codes you retrieve. You can also provide this information to your mechanic to assist in diagnosis and help avoid costly and unnecessary repairs. It is important for you to complete this form to help you and/or your mechanic have a clear understanding of your vehicle's problems.

NAME:	<input type="text"/>
DATE:	<input type="text"/>
VIN*:	<input type="text"/>
YEAR:	<input type="text"/>
MAKE:	<input type="text"/>
MODEL:	<input type="text"/>
ENGINE SIZE:	<input type="text"/>
VEHICLE MILEAGE:	<input type="text"/>

*VIN: Vehicle Identification Number, found at the base of the windshield on a metallic plate, or at the driver door latch area (consult your vehicle owner's manual for location).

TRANSMISSION:

- Automatic
 Manual

Please check all applicable items in each category.

DESCRIBE THE PROBLEM:

<hr/> <hr/> <hr/> <hr/> <hr/> <hr/> <hr/> <hr/> <hr/> <hr/>

WHEN DID YOU FIRST NOTICE THE PROBLEM:

- Just Started
- Started Last Week
- Started Last Month
- Other:

LIST ANY REPAIRS DONE IN THE PAST SIX MONTHS:

PROBLEMS STARTING

- No symptoms
- Will not crank
- Cranks, but will not start
- Starts, but takes a long time

ENGINE QUITS OR STALLS

- No symptoms
- Right after starting
- When shifting into gear
- During steady-speed driving
- Right after vehicle comes to a stop
- While idling
- During acceleration
- When parking

IDLING CONDITIONS

- No symptoms
- Is too slow at all times
- Is too fast
- Is sometimes too fast or too slow
- Is rough or uneven
- Fluctuates up and down

RUNNING CONDITIONS

- No symptoms
- Runs rough
- Lacks power
- Bucks and jerks
- Poor fuel economy
- Hesitates or stumbles on accelerations
- Backfires
- Misfires or cuts out
- Engine knocks, pings or rattles
- Surges
- Dieseling or run-on

AUTOMATIC TRANSMISSION PROBLEMS (if applicable)

- | | |
|---|---|
| <input type="checkbox"/> No symptoms | <input type="checkbox"/> Vehicle does not move when in gear |
| <input type="checkbox"/> Shifts too early or too late | <input type="checkbox"/> Jerks or bucks |
| <input type="checkbox"/> Changes gear incorrectly | |

PROBLEM OCCURS

- | | | |
|----------------------------------|------------------------------------|----------------------------------|
| <input type="checkbox"/> Morning | <input type="checkbox"/> Afternoon | <input type="checkbox"/> Anytime |
|----------------------------------|------------------------------------|----------------------------------|

ENGINE TEMPERATURE WHEN PROBLEM OCCURS

- | | | |
|-------------------------------|-------------------------------|------------------------------|
| <input type="checkbox"/> Cold | <input type="checkbox"/> Warm | <input type="checkbox"/> Hot |
|-------------------------------|-------------------------------|------------------------------|

DRIVING CONDITIONS WHEN PROBLEM OCCURS

- | | |
|--|---|
| <input type="checkbox"/> Short - less than 2 miles | <input type="checkbox"/> With headlights on |
| <input type="checkbox"/> 2 ~ 10 miles | <input type="checkbox"/> During acceleration |
| <input type="checkbox"/> Long - more than 10 miles | <input type="checkbox"/> Mostly driving downhill |
| <input type="checkbox"/> Stop and go | <input type="checkbox"/> Mostly driving uphill |
| <input type="checkbox"/> While turning | <input type="checkbox"/> Mostly driving level |
| <input type="checkbox"/> While braking | <input type="checkbox"/> Mostly driving curvy roads |
| <input type="checkbox"/> At gear engagement | <input type="checkbox"/> Mostly driving rough roads |
| <input type="checkbox"/> With A/C operating | |

DRIVING HABITS

- | | |
|---|---|
| <input type="checkbox"/> Mostly city driving | <input type="checkbox"/> Drive less than 10 miles per day |
| <input type="checkbox"/> Highway | <input type="checkbox"/> Drive 10 to 50 miles per day |
| <input type="checkbox"/> Park vehicle inside | <input type="checkbox"/> Drive more than 50 miles per day |
| <input type="checkbox"/> Park vehicle outside | |

GASOLINE USED

- | | |
|------------------------------------|--|
| <input type="checkbox"/> 87 Octane | <input type="checkbox"/> 91 Octane |
| <input type="checkbox"/> 89 Octane | <input type="checkbox"/> More than 91 Octane |

WEATHER CONDITIONS WHEN PROBLEM OCCURS

- | | |
|--|--|
| <input type="checkbox"/> 32 ~ 55° F (0 ~ 13° C) | <input type="checkbox"/> Above 55° F (13° C) |
| <input type="checkbox"/> Below freezing (32° F / 0° C) | |

CHECK ENGINE LIGHT / DASH WARNING LIGHT

- | | | |
|---------------------------------------|------------------------------------|-----------------------------------|
| <input type="checkbox"/> Sometimes ON | <input type="checkbox"/> Always ON | <input type="checkbox"/> Never ON |
|---------------------------------------|------------------------------------|-----------------------------------|

PECULIAR SMELLS

- | | |
|--|--------------------------------------|
| <input type="checkbox"/> "Hot" | <input type="checkbox"/> Gasoline |
| <input type="checkbox"/> Sulfur ("rotten egg") | <input type="checkbox"/> Burning oil |
| <input type="checkbox"/> Burning rubber | <input type="checkbox"/> Electrical |

STRANGE NOISES

- | | |
|---------------------------------|---------------------------------|
| <input type="checkbox"/> Rattle | <input type="checkbox"/> Squeak |
| <input type="checkbox"/> Knock | <input type="checkbox"/> Other |

WHAT ARE THE ADVANTAGES OF USING COMPUTER CONTROL SYSTEMS ON VEHICLES?

Vehicle Computer Control Systems can perform millions of calculations in one second, making them an ideal substitution for the much slower mechanical engine controls. By switching from mechanical engine controls to electronic engine controls, vehicle manufacturers were able to control fuel delivery and spark timing as well as other engine functions (some newer Computer Control Systems also control transmission, brakes, charging, body and suspension systems) more precisely. This made it possible for vehicle manufacturers to comply with the new, tougher emission and fuel efficiency standards mandated by State and Federal Governments.

HOW DOES A COMPUTER SYSTEM WORK ON A VEHICLE, AND WHAT IS IT'S MAIN PURPOSE?

The main purpose of the vehicle's Computer Control System is to provide maximum engine performance with the least amount of air pollution and the best fuel efficiency possible.

The Computer Control System consists of the on-board computer, and several related control devices (sensors, switches, and actuators). Most on-board computers are located inside the vehicle behind the dashboard, under the passenger's or driver's seat, or behind the right kick panel. Some manufacturers may still position it in the engine compartment. The sensors, switches, and actuators are devices such as oxygen sensors, coolant temperature sensors, throttle position sensors, fuel injectors, etc., that are located throughout the engine, and are connected by electrical wiring to the on-board computer.

The on-board computer is the heart of the Computer Control System. The computer contains several programs with pre-programmed reference values for air/fuel ratio, spark or ignition timing, injector pulse width (how much fuel is injected into the engine), engine speed, etc., for all possible driving conditions (idle, low speed driving, high-speed driving, low load, high load, etc.). The pre-programmed reference values represent the ideal air/fuel mixture, spark timing, transmission gear selection, etc., for any driving condition. These values are programmed at the factory and are specific to each vehicle model.

The on-board computer receives information (inputs) from sensors and switches located throughout the engine. These devices monitor critical engine conditions (coolant temperature, engine speed, engine load, throttle position, air/fuel ratio etc.). The computer compares the actual values received from these sensors with the reference values that are programmed in it's memory, and makes corrections as needed so that the sensor values always match the pre-programmed reference values for that particular driving condition.

Since vehicle operating conditions are constantly changing, the computer continuously makes adjustments or corrections (especially to the air/fuel mixture and spark timing) to keep all the engine systems operating within the pre-programmed reference values.

NOTE: *The computer does not make the adjustments or corrections directly. It commands other devices such as the fuel injectors, idle air control, EGR valve or Ignition Module to perform these functions. These devices are called Actuators because they initiate an action in response to the commands of the computer.*

How a Special Program in the Computer Detects and Reports Problems in the System

- Beginning in 1988 California's Air Resources Board (CARB), and later, the Federal Government's Environmental Protection Agency (EPA), required vehicle manufacturers to include a self diagnostic program capable of identifying an emissions-related fault in a system in their On-board Computers. The first generation of **On-board Diagnostics** came to be known as **OBD I**.

NOTE: *Most manufacturers (including Ford) began installing computers with On-Board Diagnostics on some of their vehicles as early as 1981.*

- OBD I is a set of self-testing or self-diagnosing instructions that are programmed into the vehicle's on-board computer.
- The program is specifically designed to detect failures in the sensors, actuators, switches and wiring of the various vehicle emissions-related systems (fuel injection system, ignition system, EGR system, catalytic converter, etc.). If the computer detects a failure in any one of these components or systems, it alerts the driver by illuminating a light on the dash (the light will illuminate **only** if it is an emissions-related problem).

- The computer also assigns a numeric code (OBD I systems utilized a 2 or 3 digit code) for each specific problem that it detects, and stores these codes in it's memory for later retrieval. The codes can be retrieved from the computer's memory with the use of a device called a "Code Reader" or a "Scan Tool".
- In addition to storing Diagnostic Trouble Codes for detected problems, most Ford computer systems are also designed to perform special Self Tests in real time, and to send the test results to the Code Reader as two- or three-digit Diagnostic Trouble Codes.

***NOTE:** With the exception of some 1994 and 1995 vehicles most vehicles from about 1982 to 1995 are equipped with **OBD I** systems.*

HISTORY OF FORD'S ELECTRONIC ENGINE CONTROL (EEC) SYSTEMS

1978: Ford Motor Company introduces its first "**Electronic Engine Control (EEC-I)**" system. This system was very limited in the control of engine functions and only controlled ignition timing, EGR flow and the air pump's injection of air into the exhaust.

1979: Ford introduces the **EEC-II system**. This system added air/fuel ratio control (feedback carburetor), throttle kicker (controls engine idle speed during start up and AC function) and canister purge control to the ECC-I system.

1980: Ford introduces the **EEC-III system**. This system included all the sensors used by the ECC-II system, with the addition of a temperature Sensor. In 1981, the ECC-III system was modified to include controls for the new Electronic Fuel Injection systems. The EEC-III system was used on some models of Ford vehicles until 1984.

1980: In addition to the EEC-III system, Ford introduced another computer control system, called the "**Microprocessor Control Unit (MCU)**". This system was used on a limited number of Ford vehicles up until 1991.

1983: Ford introduces the "**Electronic Engine Control - IV (EEC-IV)**" system. This system is capable of controlling a larger number of sensors, switches and actuators, and was used on a greater number of Ford vehicles. The ECC-IV system was used from 1983 to 1995.

1994: Ford introduces the **EEC-V** system (OBD-II). This is a highly sophisticated system that uses more special programs to enhance the computer's capability to monitor, detect and report failures, especially to the vehicle's emission system. This system was introduced on a limited number of 1994 and 1995 vehicles. Starting in 1996, all Ford vehicles (cars and light trucks) sold in the US are equipped with the EEC-V system.

NOTE: *The Ford Digital Code Reader is compatible **only** with the **MCU** and the **EEC-IV** Computer Control systems. The **EEC-I**, **EEC-II**, **EEC-III** and the **EEC-V (OBD-II)** systems require specialized equipment to diagnose computer problems and/or retrieve fault codes and are not compatible with the Ford Digital Code Reader.*

FORD COMPUTER SYSTEM OVERVIEW

Ford vehicle's computers are factory-programmed with special Self-Testing instructions that are specially designed to detect any failures in the various systems that the vehicle's computer monitors and controls. The computer monitors the vehicle's sensors (oxygen sensors, coolant temperature sensors, mass airflow sensors, EGR valve, MAP sensors, etc.) and actuators (fuel injectors, EGR system, idle air control, cooling fan, canister purge solenoid, spark advance, etc.) for proper operation. All of these devices are connected to the vehicle's computer by wires.

The sensors communicate with the computer by sending voltage signals (inputs) that correspond with the vehicle's current operating condition. If the voltage that the computer receives from a particular sensor does not agree with the voltage value that is programmed in its memory for that particular driving condition. A Diagnostic Trouble Code is generated that pertains to that particular circuit or system.

Actuators receive commands from the computer in the form of voltage signals to perform a certain functions or adjustment.

Example: The computer might command a fuel injector to increase the amount of fuel injected into the engine. After the computer commands the fuel injector to inject more fuel in to the engine, it then monitors the voltage signal from that injector to ensure that the injector has responded. If the fuel injector's voltage signal does not change, it indicates that the fuel injector is not responding to the computer's command. The computer then determines that there is a problem in the injector or injector circuit, and generates a code related that particular problem. This code is sent to the Code Reader during the Self Test procedure.

IMPORTANT: When the computer is in Self Test mode (is testing the sensors or actuators for proper operation), it relies on voltage signals that it sends to and/or receives from the sensors or actuators to determine whether or not these components are operating properly. The sensors and actuators are all connected to the computer by wires. If any defects are present in any part of the circuit that connects these devices to the computer (such as defective connectors or wires, faulty grounds, improper voltage, shorts etc.), the voltage signal that the computer receives from these devices will be affected. The computer has no way of determining if the improper voltage signal is being caused by a defect in the circuit or by the sensors or actuators themselves. Keep this in mind when servicing Fault Codes, and do not replace any devices (sensors or actuators) before checking the complete circuit (or circuits) that are part of the device from which the code was generated.

BEFORE YOU BEGIN

- Fix any known mechanical problems before performing any test.

Make a thorough check before starting any test procedure. Loose or damaged hoses, wiring or electrical connectors are often responsible for poor engine performance, and in some cases they may cause a "false" fault code.

Please read your vehicle's service manual for proper connection of vacuum hoses, electrical wiring and wiring harness connectors. Check the following areas:

- All fluid levels** - check the oil, power steering, transmission (if applicable), coolant and other engine fluids.
- Air cleaner and ducts** - check for holes, rips, excessive dirt in filter, and for disconnected ducts. You may wish to check your owner's manual to determine when you should change the air filter.
- Belts** - check for ripped, torn, brittle, loose or missing belts.
- Mechanical linkage associated with sensors** - Refer to your vehicle's service manual for locations.
- Rubber (vacuum/fuel) and steel hoses** - check for leaks, cracks, blockage or other damage; check for proper routing.
- Spark plugs and wires** - check for damaged, loose, disconnected or missing spark plug wires.
- Battery terminals** - make sure battery terminals are clean and tight; check for corrosion or broken connections. Verify proper battery and charging system voltage.
- Electrical connectors and wiring** - make sure wire insulation is in good condition and there are no exposed wires. Make sure all cables are connected securely.
- Verify that the engine** is mechanically sound. If necessary, perform a compression check, engine vacuum check, timing check (if applicable), etc.

Preparing The Code Reader For Use

Installing the Battery

- 2 - "AA" batteries are required to perform tests.
- Batteries sold separately.
- a. Remove the battery compartment cover from the back of the Code Reader.

- b. Match battery terminals with battery connector contacts.
- c. Place batteries into battery compartment.
- d. Reinstall battery compartment cover.

TEST CONNECTORS

- The gateway to your vehicle's onboard computer.

Ford equips its vehicles with special Test Connectors that make it possible to connect specialized testing equipment that communicates with the vehicle's onboard computer.

Ford's vehicle test connectors are usually dark in color (BLACK or GREY) and found under the hood. Sometimes they have a plastic cover over them or are labeled EEC Test. The connectors can be found in the following general locations in the engine compartment:

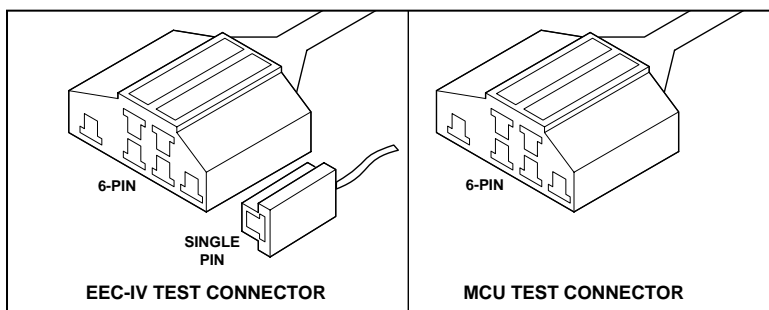

- Near the front corner (right or left).
- Near the fender well (right or left).
- Near the fire wall (right or left).

CONNECTING THE FORD CODE READER TO THE VEHICLE'S TEST CONNECTOR(S)

NOTE: The Code Reader is designed to match the computer's test connector. When properly connected, the test connector should match the pre-molded guides around the Code Reader pins (as shown on next page).

Forcing the test connector onto the Code Reader improperly may result in damage to the Code Reader and possible damage to the vehicle's computer system.

- For the EEC-IV Computer System (most vehicles built after 1984) connect the Code Reader to **BOTH**.

1. large, six pin female connector with molded housing
2. small, single pin female connector

NOTE: 1988 and newer vehicles may have more than one similar connector for other systems (i.e. Anti-Lock Brakes), only the connector with an extra single pin is the correct test connector for computer service codes use. If you have any questions about the correct connector please refer to your vehicle's service manual for detailed information.

- For the MCU System (most vehicles built between 1981-1983) connect the Code Reader to the six pin female connector only.

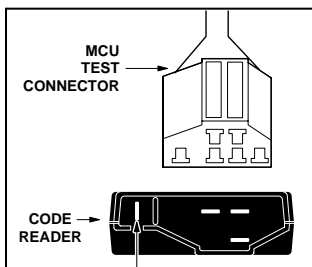
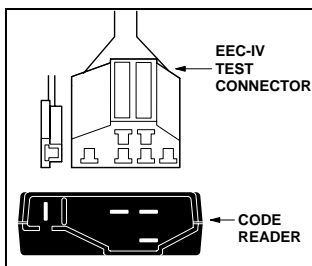

Optional Extension Cable

For one person operation, a 6' optional extension cable for test connection is available through your local store or service department. The extension cable allows you to do all the code reading without the help of another person.

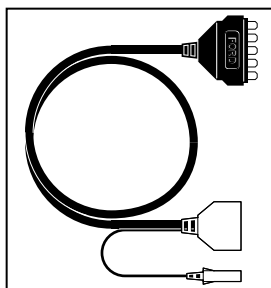

FUNCTIONS OF THE FORD CODE READER

The Ford Digital Code Reader is a diagnostic tool that is specially designed to connect to the vehicle's test Connector(s) to communicate with the vehicle's computer.

The Code Reader does not generate codes. The Code Reader serves as a "key" that links to, and opens communication with the vehicle's computer to prompt the computer to perform Self Tests, and to receive test results or retrieve codes.

The vehicle's computer generates and assigns fault codes whenever it detects a problem in any of the various systems that it monitors and/or controls. Once the Code Reader is connected to the vehicle's Test Connector(s), the user can signal the computer to perform the Self-Tests (by pressing the **TEST/HOLD** button). The computer then starts performing a Self Test of all the components and/or circuits it controls. The results of the tests are sent to the code reader as numerical codes to help the repairperson pinpoint a particular problem in any of the computer control systems.

This Code Reader is designed to retrieve Diagnostic Trouble Codes from Ford **EEC-IV** and **MCU** systems only.

Code Reader Controls and Indicators

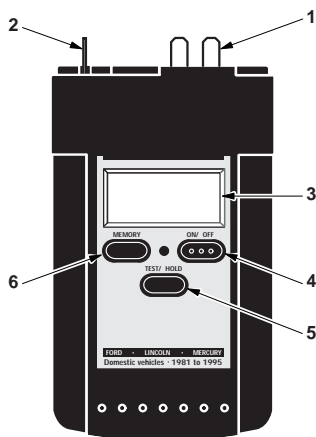

1. **Code Reader Connector** - Connects to the vehicle's six-pin Test Connector (the six-pin test connector is used on both MCU and ECC-IV systems).
2. **Code Reader Connector** - Connects to the vehicle's single-pin Test Connector. (the single-pin Test Connector is used on EEC-IV systems only; MCU systems are not equipped with single pin test connectors).
3. **LCD Display** - Displays test results, Diagnostic Trouble Codes and Code Reader functions.
4. **ON/OFF Button** - Turns the code reader On and Off.
5. **TEST/HOLD Button**: Toggles between TEST and HOLD functions.

- 6. MEMORY Button** - When pressed, displays on demand, one at a time, the retrieved Diagnostic Trouble Codes that are saved in the Code Reader's memory (the Code Reader memory has the capacity to store up to 12 retrieved numeric Diagnostic Trouble Codes).

Display Functions

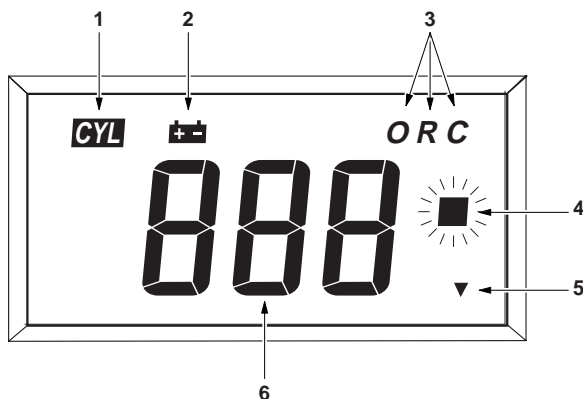

- 1. CYL Icon:** When visible, this icon indicates that the number shown on the the Code Reader's display is a cylinder identification code. Cylinder codes identify the number of cylinders of the engine under test. Cylinder identification is only displayed when performing a KOER Self Test.
- 2. BATTERY Icon:** When visible, this icon indicates that the Code Reader's internal batteries are low. Batteries should be replaced before performing any tests.
- 3. O, R, and C Icons:** These icons indicate the type of test being performed, and indicate if the code being received is a KOEO, KOER or CM code:

O = Key On Engine Off (KOEO) Test/code

R = Key On Engine Running (KOER) Test/code

C = Continuous Memory (CM) code

These icons also identify the "code type" when viewing Diagnostic Trouble Codes that are saved in the Code Reader's memory.

4. **"FLASHING" SQUARE Icon:** This icon flashes when the Code Reader receives Diagnostic Trouble Codes from the vehicle's computer. The icon flashes each time a code is received; the code is then shown on the Code Reader's display.
5. **LINK Icon:** When visible, this icon indicates that the Code Reader is linked to the vehicle's computer, and the computer is in test mode.
6. **Diagnostic Trouble Code Display Area:** Displays the Diagnostic Trouble Code number. Each fault is assigned a code number that is specific to that fault.

OVERVIEW OF FAULT CODES

IMPORTANT: *Retrieving and utilizing Diagnostic Trouble Codes (DTC's) for troubleshooting vehicle operation problems is only one part of an overall diagnostic strategy. **Never replace a part** based only on the Diagnostic Trouble Code Definition. Always consult the vehicle's service manual for more detailed testing instructions. Each DTC has a set of testing procedures, instructions and flow charts that must be followed to confirm the exact location of the problem. This type of information is found in the vehicle's service manual.*

- a. Fault Codes are called "Diagnostic Trouble Codes" (DTCs), "Trouble Codes", "Fault Codes" or "Service Codes" (these terms are used interchangeably throughout this manual). These numeric codes are used to identify a problem in any of the systems that are monitored by the vehicle's on-board computer.
- b. Each Fault Code is assigned a message that identifies the circuit, component or system area where the problem was detected.
- c. Ford Diagnostic Trouble Codes are composed of two- or three-digit numbers.
 - Most early model Ford vehicles (up to 1991) use a two-digit code system.
 - Most late model Ford vehicles (1992 to 1995) use a three-digit code system.

The computer records codes for three types of conditions:

1. It records Fault Codes for problems that are present at the time the Self-Tests are performed (the Code Reader is used to place the vehicle's computer in Self-Test Mode; the procedures are described in detail later in this manual). These types of codes are usually called "Hard Codes". Hard Codes will make the check engine light or Malfunction Indicator Lamp (MIL), if equipped, on the dash to come on and stay on solid.
2. It records and saves Fault Codes for "Intermittent Problems" (not applicable to MCU systems). These problems come and go intermittently. Intermittent Fault Codes may cause the Check Engine/Malfunction Indicator Lamp (MIL) light to flicker on dash.

3. It records and retains in its memory (not applicable to MCU systems) a record of faults that occurred in the past but are no longer present. The vehicle's computer keeps these Fault Codes in its memory for a specific period of time (40 Warm Up cycles* for most fault Codes, 80 Warm up cycles for others) even if the problems that caused these codes to be set in the first place are no longer present.

***Warm-up Cycle** - A Warm-up Cycle is defined as vehicle operation (after an engine off period) where the engine temperature rises at least 40°F (22°C) from the temperature present when the vehicle was first started, and the engine temperature reaches at least 160°F (70°C).

NOTE: *The Code Reader does not generate codes. The Code Reader serves as a "key" that links to, and opens communication with the vehicle's computer to prompt the computer to perform Self Tests, and to receive test results or retrieve codes.*

OVERVIEW OF FORD CODE RETRIEVAL PROCESS

Ford's computer self-diagnostic system is divided into three main sections: 1. "Key On Engine Off" (KOEO) Self Test, 2. "Continuous Memory" (CM) Self-Test and 3. "Key On Engine Running" (KOER) Self Test. These Self-Tests are specially designed to monitor and/or test the various components and circuits that are controlled by the vehicle's computer, and to save and/or transmit diagnostic test results to the Code Reader in the form of numerical fault codes.

- The "Continuous Memory" Self Test is designed to run continuously whenever the vehicle is in normal operation. If a fault is detected by the "Continuous Memory" Self Test, a fault code is saved in the vehicle's computer memory for later retrieval.

NOTE: *Continuous Memory codes only apply to EEC-IV systems and are retrieved during the KOEO Self Test.*

- Ford designed its On-Board Diagnostic Self Tests in such a way that in order to properly diagnose a problem, you must performed all the Self Tests, in the proper sequence. As described above, some tests are designed to detect problems only when the vehicle is in normal operation, some tests are designed to activate components and detect problems only with the Key On and Engine Off, and other

tests are designed to activate components and test their operation only with the Key On and Engine Running. Do not take short cuts. If you fail to perform a test, or you perform a test out of sequence, you might miss a problem that is only detected during that particular test procedure. To properly receive Diagnostic Trouble Codes from the Ford computer control system, perform the Self Tests in the following order:

1. Key On Engine Off (KOEO) Self Test
2. Ignition Timing Check (vehicle Ignition Timing System must be working properly before the KOER Self Test can be performed)
3. Key On Engine Running (KOER) Self Test

IMPORTANT:

- *To retrieve Diagnostic Trouble Codes from **EEC-IV** Systems proceed to the next section below.*
- *To retrieve Diagnostic Trouble Codes from MCU systems proceed to page 65.*

KEY ON ENGINE OFF (KOEO) TEST PROCEDURES (EEC-IV SYSTEMS)

NOTE: *During the KOEO Self Tests two groups of codes will be sent to the Code Reader by the vehicle's computer.*

- *The first groups of codes sent to the Code Reader are called "KOEO Self Test codes",*
- *followed by the second group called "Continuous Memory Codes".*

NOTE: *Before the computer sends the second group of codes to the Code Reader, it first sends a "separator code" (code 10) to separate the first group of codes from the second group.*

- Always observe safety precautions before and during testing process.
 - **ALWAYS** check Code Reader battery before retrieving fault codes.
 - Fix any known mechanical problems before this test.
1. Warm-up engine to normal operating temperature before performing this test.
 2. Turn ignition off.

3. With Code Reader off, connect to the vehicle's test connectors (see page 18 for test connector location).
 - Both the large and small connectors must be connected.
4. If your vehicle is equipped with one of the following configurations, perform the added procedures as described below.
 - For 4.9L engines with standard transmission: press and hold the clutch until all Codes are sent (Steps 4 to 10).
 - For 7.3L diesel engines: press and hold accelerator until all codes are sent (Step 4 to 10).
 - For 2.3L turbo engines with octane switch: put switch in premium position.

NOTE: Do not press throttle or brake, or move steering wheel, during this test unless instructed.

5. Turn ignition on. **DO NOT START THE ENGINE.**

WARNING: Keep away from any potentially moving parts.

6. Press and release the **ON/OFF** button to turn the Code Reader "ON".

- Three zeros should be visible on the Code Reader display at this time.



7. Press and release the **TEST/HOLD** button to put the Code Reader in Test Mode.

- When the code reader is put in test mode it signals the vehicle's computer to start performing the Self-Test. The display will show a "Triangle" icon on the lower right hand corner of the display to indicate that the Code Reader is linked to the vehicle's computer and is in test mode.



NOTE: As soon as the **TEST/HOLD** button is pressed the vehicle's computer enters the Self Test mode. Clicking sounds will be heard coming from the engine. This is normal. It indicates that the vehicle's computer is activating relays, solenoids, and other components to check their operation.

WARNING: On some vehicles equipped with an Electric Cooling Fan, the computer activates the cooling fan to check its operation. To avoid injury, keep hands or any part of your body a safe distance from engine during the test.

8. After 6 to 10 seconds (it may take longer on some vehicles) the computer will start sending the KOEO Self Test results to the Code Reader in the form of numerical codes.

NOTE: Most Ford EEC-IV vehicle computers up to 1991 use a two-digit code system. From 1991 to 1995 most use a three-digit code system.

- A square icon (on the right-hand side of the screen) displays and flashes each time the Code Reader receives a code. The code is then shown on the Code Reader's display.



- A small "O" is shown in the upper right-hand corner of the display to indicate that the code being received is a KOEO Self Test fault code.

NOTE: Each code is repeated two times.

9. If no problems are found during the KOEO Self Test, the computer sends a "pass code" (code 11 or 111) to the Code Reader.

- Code 11 or 111 indicates that all the relays and actuators (and their related circuits) that were tested are OK, and no faults were found.

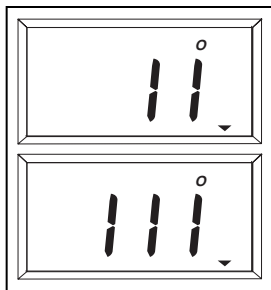

- If the Code Reader fails to display codes, consult the troubleshooting guide on pages 75 and 76.

10. Approximately six to nine seconds after the Code Reader receives the last KOEO Self Test fault code(s), a "separation code" (code 10) is sent to the Code Reader.



- Code 10 is not a fault code. Code 10 is a “separation code” used to separate the first group of codes (KOE0 Self Test Codes) from the Continuous Memory group of codes.
 - Code 10 also serves as an indication to the user that the vehicle's computer has completed the first part of the KOE0 Self Test, and that the next groups of codes to be displayed are Continuous Memory codes.
11. Approximately nine seconds after the Code Reader receives the “separation code” (code 10), it begins retrieving any Continuous Memory codes that are present in the vehicle's computer memory.

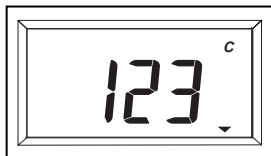

- A small "C" is shown in the upper right-hand corner of the display to indicate that the codes being retrieved are Continuous Memory codes.
 - If no Continuous Memory codes are present in the vehicle's computer memory, The code reader will display a “pass code” (code 11 or 111).
12. After all the KOE0 Self Test Codes and Continuous Memory codes have been received by the Code Reader (wait until the flashing square icon no longer appears on the display for 30 consecutive seconds to ensure that all the codes have been retrieved), press the **ON/OFF** button to turn the Code Reader off, disconnect the Code Reader from the vehicle's test connectors, and turn the ignition off.
- The codes retrieved are now stored in the Code Reader's memory.
13. To view codes stored in the Code Reader's memory, press the **ON/OFF** button to turn the Code Reader on, then press and release the **MEMORY** button; the first stored code will display. Continue pressing and releasing the **MEMORY** button to scroll through the stored codes until all the codes have been displayed.

NOTE: All retrieved codes will stay in the Code Reader's memory and will only clear from the Code Reader's memory if the Self Test procedure is performed again (codes from a prior test will clear automatically when new Self Test is performed) or if batteries are removed from the Code Reader.

14. If any KOEO Self Test Fault Codes were retrieved:

- Refer to page 46 for "Fault Code Definitions for EEC-IV Systems". Match the codes retrieved with the codes shown in the Fault Code Definition list to determine the fault.
- Use the code definitions as a guide, and follow the manufacturer's service procedures in the vehicle's service repair manual to troubleshoot and repair faults.
- All KOEO Self Test codes (except Continuous Memory Codes) that are received by the Code Reader during the KOEO Self test represent problems that are present now (at the time the test is performed). The related vehicle problems that cause these codes to set must be repaired using the procedures described in the vehicle's service repair manual.
- ***Do not service "Continuous Memory" codes at this time. See IMPORTANT note at end of KOEO procedure for more details.***



15. After all repairs have been completed, repeat the KOEO Self Test. If a "pass code" (code 11 or 111) is received, it indicates that the repairs were successful, and you can proceed to perform Ignition Timing Check (see page 30). If a "pass code" (code 11 or 111) is not received, the repair was unsuccessful. Consult the vehicle's service manual and recheck repair procedures.

DO NOT PROCEED TO "IGNITION TIMING CHECK PROCEDURE " UNTIL A "PASS CODE" (CODE 11 OR 111) FOR "KOE0 SELF TEST" IS OBTAINED.

IMPORTANT: Before Continuous Memory codes can be serviced, both the KOEO and the KOER Self-Tests must pass (a code 11 or 111 is obtained). After both of these tests have passed, erase the vehicle's computer memory (see page 37), take the vehicle for a short drive, then repeat the KOEO Self test. If any Continuous Memory faults are present, service them at this time. Refer to page 46 for "Fault Code Definitions for EEC-IV Systems", and consult the vehicle's service repair manual for servicing Continuous Memory Fault Codes.

ENGINE TIMING CHECK (EEC-IV SYSTEMS)

IMPORTANT: Before performing the KOER Self Test, the vehicle's Ignition Base Timing and the computer's ability to electronically control timing advance must be checked for proper operation. Maladjustment of ignition timing, or a problem in the advance circuit, might generate false fault codes when performing the KOER Self Test that would cause the test to be invalid. Use the following procedures to check for proper ignition timing and to verify the computer's ability to electronically advance ignition timing.

This procedure is used to check for proper ignition timing, and to verify the computer's ability to electronically advance ignition timing.

- For 1992 and older vehicles, the Code Reader can be used in combination with a timing light to check ignition timing and the vehicle's computer ability to advance ignition timing. Follow the procedures in paragraph "A".
- For 1993 and newer vehicles, follow procedures in paragraph "B".

A. Timing Procedures for 1992 and Older Vehicles (excluding diesel engines)

- Always observe safety precautions before and during Self-Test.
 - ALWAYS check Code Reader battery before retrieving fault codes.
 - A timing light is required to perform this test.
 - The vehicle must pass the KOEO test before performing this test.
1. Turn ignition off.
 2. Turn the Code Reader off (press the **ON/OFF** button, as necessary), then connect the Code Reader to the vehicle's test connectors.
 - Both the large and small connectors must be connected.
 3. Start the engine.
 4. Press and release the **ON/OFF** button to turn the Code Reader "ON".

5. Press and release the **TEST/HOLD** button to put the Code Reader in test mode. The vehicle's computer will perform a Key On Engine Running Self test.
 - A square icon (on the right-hand side of the screen) displays and flashes each time the Code Reader receives a code. The code is then shown on the Code Reader's display.
6. Wait until all codes have been sent (the flashing square icon no longer appears) and, without disconnecting or turning the Code Reader off, proceed to step 7.

NOTE: Do not concern yourself with the KOER test results or any fault codes received at this time. The purpose of briefly performing the KOER test is to put the computer into an "Ignition Timing Check mode". This mode allows you to test the ability of the vehicle's computer to electronically control/advance ignition timing. Once the timing check confirms that ignition timing is functioning correctly, you can properly perform the KOER Self Test.

7. The vehicle's computer is programmed to advance ignition timing 20° (+/- 3°) above the vehicle's "base timing" value, and to freeze this setting for two minutes from the time the last KOER code is received by the Code Reader. This allows the user to check the computer's ability to advance ignition timing.
 - Within this two-minute period, (remember, timing degrees will remain fixed for only two minutes after the last KOER code is received by the Code Reader), check the ignition timing with a timing light and ensure that it is 20° above the specified base timing value (+/- 3°).

Example: If base timing specification is 10° BTDC, the acceptable timing light reading should be in the range of 27° to 33° BTDC.

NOTE: Base timing specifications can be found on the Vehicle Emission Control Information (VECI) decal. The decal is located under the hood or near the radiator. If the VECI decal is missing or damaged, refer to your vehicle's service manual for specifications.

8. If timing light readings are not within the acceptable range, base timing may be out of adjustment, or the computer may have problems with the timing advance circuit.

- Turn the engine off and disconnect the Code Reader from the test connectors. Refer to the vehicle's service manual for instructions on adjusting and/or repairing ignition timing.
- 9. If timing light readings are within the acceptable range, base timing and the vehicle's computer ability to advance timing are working properly.
 - Turn engine off and disconnect the Code Reader from test connectors. Proceed to page 32 and perform the KOER Self Test.

B. Timing Procedures for 1993 And Newer Vehicles (excluding diesel engines)

Due to the complexity and large variation of Ford 1993 and newer models with computer-controlled ignition timing systems, timing adjustment and/or checking procedures vary widely from one model to the next. Refer to the vehicle's service manual for procedures to check and adjust timing. **DO NOT ATTEMPT TO ADJUST TIMING WITHOUT MANUFACTURER'S SPECIFICATIONS AND PROCEDURES.**

KEY ON ENGINE RUNNING (KOER) SELF TEST (EEC-IV SYSTEMS)

IMPORTANT:

- *The KOEO Self Test (page 25) must be performed first, and a "pass code" (code 11 or 111) must be obtained before performing the KOER Self Test; otherwise, results of the KOER Self Test may be invalid.*
- *Ignition timing and timing advance must be operating properly in order for the KOER Self Test results to be considered valid. Perform an Ignition Timing Check (page 31) before performing the KOER Self Test.*
- Always observe all safety precautions before and during the testing process.
- **ALWAYS** check the code reader's batteries before the test.

1. Warm up the vehicle to normal operating temperature.
 - Start the engine, increase engine speed to 2000 RPM, and maintain engine speed for approximately two to three minutes. In most cases, this is sufficient to allow the engine to warm up to normal operating temperature.

NOTE: Failure to warm engine to normal operating temperature before performing KOER test might result in a false Fault Code being sent to the code reader.

2. Turn ignition off.
3. Turn the Code Reader off (press the **ON/OFF** button, as necessary), then connect the Code Reader to the vehicle's test connectors.

- Both the large and small connectors must be connected.

4. Turn ignition on and start the engine.

5. Press and release the **ON/OFF** button to turn the Code Reader "ON".

- Three zeros should be visible on the display at this time.



6. Press and release the **TEST/HOLD** button to put the Code Reader in Test Mode.

- A square icon (on the right-hand side of the screen) displays and flashes each time the Code Reader receives a code. The code is then shown on the Code Reader's display.



- A small "R" is shown in the upper right-hand corner of the display to indicate that the code being received is a KOER Self Test Fault Code.

7. The first code displayed by the code reader is the Cylinder Identification (ID) Code.

- The cylinder ID code identifies the number of cylinders of the vehicle that is under test.

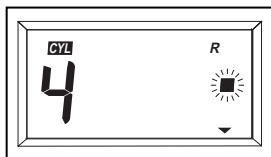

NOTE: If code 98 or 998 displays instead of a cylinder ID code, the vehicle is operating in "Failure Mode". The computer goes into failure mode when it detects a signal from a sensor that indicates the sensor has failed and is completely out of specifications. The computer substitutes a fixed signal value for the failed sensor to keep the vehicle running. Failure mode codes 98 or 998 are usually accompanied by one or more Diagnostic Trouble Codes that indicate the failed sensor. A vehicle operating in failure mode is operating at a minimal level, and the faults that are causing these Diagnostic Trouble Codes to set must be repaired as soon as possible.

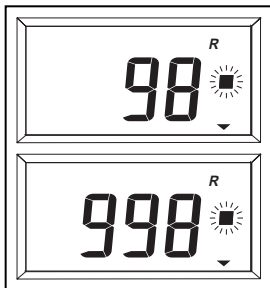

8. Check your vehicle's service manual to see if your vehicle is equipped with a Power Steering Pressure Switch, Brake On/Off (BOO) Switch and/or an Overdrive Cancel Switch. If your vehicle is equipped with these features, perform the following immediately after retrieving the Cylinder ID code (step 7).

NOTE: If you are unsure of your vehicle's equipment, it is recommended that you perform these procedures anyway.

- If your vehicle has a Power Steering Pressure Switch (PSPS), turn the steering wheel a half turn; wait three to five seconds, then release. The computer checks for proper variations in power steering pressure during this procedure. Failure to perform this procedure will generate a Fault Code.
 - If your vehicle has a Brake On/Off (BOO) Switch, step on the brake pedal once, and release. The computer checks the Brake On/Off Switch for proper operation during this procedure. Failure to perform this procedure will generate a Fault Code.
 - If your vehicle has an Overdrive Cancel Switch (OCS), turn the switch on and off once. Failure to perform this procedure will generate a Fault Code.
9. Thirty to sixty seconds after the cylinder ID code is received, code 10 may display (code 10 is not applicable to all vehicles). If a code 10 is displayed, quickly press the accelerator pedal to the floor and release, then proceed to step 10. If code 10 is not displayed proceed directly to step 10.

- Code 10 is not a fault code. The vehicle's computer uses code 10 to signal the Code Reader operator to perform a Wide Open Throttle (WOT) test (quickly press and release the accelerator pedal).



This procedure is called the **Dynamic Response Check**. The computer uses this brief Wide-Open Throttle (WOT) test to verify the operation of the Throttle Positioning, Mass Airflow, Manifold Absolute Pressure and Knock Sensors.

- If you fail to press the accelerator to the floor as instructed in step 9, a Dynamic Test Failure Code may be generated.
10. After the dynamic test is completed (if applicable), the vehicle computer proceeds to test the actuators, switches, relays and their related circuits. If any problems are detected in any of these components or circuits as they are tested, a Diagnostic Trouble Code is sent to the Code Reader.

NOTE: Each code is repeated two times.

11. If no problems are found during the KOER Self Test, the computer sends a "pass code" (code 11 or 111) to the Code Reader.

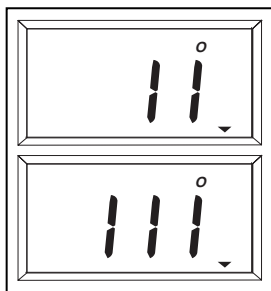

- Code 11 or 111 indicates that all the relays and actuators and their related circuits that were tested during the KOER Self-Test are OK, and no faults were found.

NOTE: Most Ford EEC-IV vehicle computers up to 1991 use a two-digit code system. From 1991 to 1995 most use a three-digit code system.

12. After all the KOER Self Test codes are received by the Code Reader (wait until the flashing square icon no longer appears on the screen for 30 consecutive seconds to ensure that all the codes have been retrieved), turn the Code Reader off, turn the engine off, and disconnect the Code Reader from the vehicle's test connectors. The codes received are now stored in the code reader's memory.

13. To view codes stored in the Code Reader's memory, press the **ON/OFF** button to turn the Code Reader on, then press and release the **MEMORY** button; the first stored code will display. Continue pressing and releasing the **MEMORY** button to scroll through the stored codes until all the codes have been displayed.

NOTE: All retrieved codes will stay in the Code Reader's memory and will only clear from the Code Reader's memory if the Self Test procedure is performed again (codes from a prior test will clear automatically when new Self Test is performed) or if batteries are removed from the Code Reader.

14. If any KOER Self Test Fault Codes were received:

- Refer to page 46 for "Fault Code Definitions for EEC-IV Systems". Match the codes retrieved with the codes shown in the Fault Code Definition list to determine the fault.



- Use the code definitions as a guide, and follow the manufacturer's service procedures in the vehicle's service repair manual to troubleshoot and repair faults.
 - All KOER codes that are received by the Code Reader during the KOER Self Test represent problems that are present now (at the time the test is performed). The related vehicle problems that caused the codes to be set must be repaired using the procedures described in the vehicle's repair manual.
15. After all repairs have been completed, repeat the KOER Self Test.
 - If a "pass code" (code 11 or 111) is received, it indicates that the repairs were successful and all the related systems are working properly.
 - If a "pass code" (code 11 or 111) is not received, the repair was unsuccessful. Consult the vehicle's service manual and recheck repair procedures.

ERASING CODES FROM EEC-IV SYSTEMS

IMPORTANT: *Continuous Memory Codes are the only ones that are saved in the vehicle's computer long-term memory. KOEO and KOER Self Test fault codes represent problems that are present at the time these tests are performed and are detected by the computer only while the problem is present. KOEO and KOER codes are not saved in the vehicle's computer memory, and if the problem that caused these faults to set is repaired, these codes will no longer be present when the Self Tests are performed.*

This procedure clears Continuous Memory codes from the vehicle's computer memory.

- **Erase codes only when all repairs have been completed.**
 - Always observe safety precautions before and during testing process.
 - **ALWAYS** check Code Reader battery before retrieving fault codes.
1. Turn ignition off.
 2. Turn the Code Reader off (press the **ON/OFF** button, as necessary), then connect the Code Reader to the vehicle's test connectors.
 - Both the large and small connectors must be connected.
 3. Turn on ignition. **DO NOT START THE ENGINE.**

WARNING: *Keep away from any potentially moving parts.*
 4. Press and release the **ON/OFF** button to turn the Code Reader "ON".
 - Three zeros should be visible on the display at this time.
 5. Press and release the **TEST/HOLD** button to put the Code Reader in Test Mode.
 - When the Code Reader is put into test mode, it signals the vehicle's computer to start performing the Self-Test. The display will show a "Triangle" icon on the lower right hand corner of the display to indicate that the Code Reader is linked to the vehicle's computer and is in test mode.

NOTE: As soon as the TEST/HOLD button is pressed the vehicle's computer enters the Self Test mode. Clicking sounds will be heard coming from the engine. This is normal. It indicates that the vehicle's computer is activating relays, solenoids, and other components to check on their operation.

WARNING: On some vehicles equipped with an Electric Cooling Fan, the computer activates the cooling fan to check its operation. To avoid injury, keep hands or any part of your body a safe distance from engine during the test.

6. After 6 to 10 seconds (it may take longer on some vehicles) the computer will start sending the KOEO Self Test results to the Code Reader in the form of numerical codes.

- A square icon (on the right-hand side of the screen) displays and flashes each time the Code Reader receives a code. The code is then shown on the Code Reader's display.

7. As soon as the code reader starts receiving codes, press and release **TEST/HOLD** button to put Code Reader on HOLD.

- The Code Reader must be put on HOLD while it is retrieving codes in order for "Continuous Memory" codes to be erased from the computer's memory.



8. "Continuous Memory" codes are erased.
9. Turn off the ignition and disconnect the Code Reader from the test connectors.

ADDITIONAL TESTS FOR EEC-IV SYSTEMS

NOTE: These tests are additional, supplemental tests, and are not needed to retrieve Diagnostic Trouble Codes. Ford has included them to further assist the technician / do-it-yourselfer in the troubleshooting of vehicle problems.

Relay and Solenoid Test (Output State Check)

The "Output State Check " is a special program in the vehicle's computer that allows the user to energize (turn ON) and de-energize (turn OFF), on command, most of the actuators (relays and solenoids) that are controlled by the computer.

- Use this test to check computer output voltages and relay/solenoid operation.

NOTE: *The fuel injectors and fuel pump are not energized during this test.*

- The Output Check Mode is activated immediately after the Key On Engine Off (KOEO) Self Test is performed.
1. Perform the **Key On Engine Off (KOEO) Self Test**, steps 1 through 11 (refer to page 25 for procedures).
 2. Wait until the Code Reader retrieves all the KOEO Self Test and Continuous Memory codes.
 - The flashing square icon no longer appears on the display when all the codes have been retrieved.
 3. Immediately after all Continuous Memory codes have been retrieved, step on the accelerator pedal once, then release. This activates the Output State Check and energizes most of the actuators (relays and solenoids) that are controlled by the vehicle's computer.

NOTE: *If your vehicle is equipped with an Integrated Vehicle Speed Control, disconnect the vacuum supply hose from the speed control servo before pressing the accelerator. Reconnect vacuum hose after test.*

- The square icon will appear and stays on solid on the right hand side of the code reader's display to indicate that the Actuators are energized.
4. To de-energize the actuators, press the accelerator pedal once and release. The square will disappear, indicating that the actuators are de-energized.
 - The procedure can be repeated as many times as desired by pressing and releasing the accelerator pedal to energize and de-energize the Actuators.
 5. Consult the vehicle's service manual for a list of all the actuators (solenoids and relays) controlled by the computer that apply to the vehicle under test, and which actuators should energize and de-energize when performing the "Output State Check". All applicable actuators should be on when energized and off when de-energized.

- The vehicle's computer sends a voltage output signal or a ground signal to energize the actuators. If an actuator is not responding to the Output State Check, follow the procedures described in the vehicle's service manual to check computer actuator output circuit voltages and/or grounds.
6. After performing the Output State Check, turn off the ignition and disconnect the Code Reader from the test connectors.

Cylinder Balance Test

(Vehicles equipped with Sequential Electronic Fuel Injected (SEFI) systems only)

The Cylinder Balance Test assists in finding a weak or non-contributing cylinder. The computer shuts off fuel (cuts off power to injectors) to each cylinder, in sequence, and monitors for RPM changes (drop). Based on this information, the computer determines if all the cylinders are contributing power equally (for proper engine operation), or if some cylinders are only contributing partially or not contributing at all.

SEFI Introduction

Sequential Electronic Fuel Injection (SEFI) belongs to a family of fuel injection systems called "Multiport/Multipoint Fuel Injection".

Multiport (MFI) fuel injection systems contain one fuel injector per cylinder, and the vehicle's computer electronically controls their operation. On some multiport fuel injection system, the injectors all fire at the same time and at every engine revolution. On other systems the injectors fire in groups and/or at every other engine revolution.

What distinguishes Sequential Electronic Fuel Injection systems from other multiport fuel injection systems is that each injector is independently energized and fires sequentially one after the other in the proper firing order. This gives the vehicle computer more control to cut the fuel to one injector at a time (this can't be accomplished on the other systems because they fire in groups of two or more injectors).

The computer can be put in "Cylinder Balance Test Mode" by performing the KOER Self Test, waiting until all the KOER codes have been transmitted to the Code Reader, and then lightly taping the accelerator (follow the Cylinder Balance Test procedures, on next page).

Cylinder Balance Test Procedure

- Always observe safety precautions before and during testing process.
 - **ALWAYS** check Code Reader battery before retrieving fault codes.
 - The vehicle must pass the KOEO test before performing this test.
1. Turn ignition off.
 2. Turn the Code Reader off (press the **ON/OFF** button, as necessary), then connect the Code Reader to the vehicle's test connectors.
 - Both the large and small connectors must be connected.
 3. Turn the ignition on and start the engine.
 4. Press and release the **TEST/HOLD** button to put the Code Reader in test mode. The vehicle's computer will perform a Key On Engine Running Self test.
 - A square icon (on the right-hand side of the screen) displays and flashes each time the Code Reader receives a code. The code is then shown on the Code Reader's display.
- NOTE:** *Each code is repeated twice*
5. Wait until all the codes are sent (the flashing square icon no longer appears), then, without disconnecting or turning Code Reader or the engine off, proceed to step 6.

NOTE: *Do not concern yourself with the KOER test results or any KOER fault codes received at this time. The purpose of briefly performing the KOER test is to put the computer into the "Cylinder Balance Test Mode"; this mode will allow the user to determine if all the cylinders are contributing equally to vehicle operation.*
 6. After all the KOER codes have been received by the Code Reader, lightly press the accelerator, about one quarter of the way down, then release.
 - **For 1986 models ONLY:** Fully press accelerator once and release.

- The computer is now in Cylinder Balance Test Mode, and will start cutting fuel to each cylinder in sequence to determine if all the cylinders are contributing equally. **It may take up to five minutes before the test results are transmitted to the Code Reader.**
7. After the computer finishes performing the Cylinder Balance Test, the test results are sent to the Code Reader in the form of two digit codes.
- The computer compares the power contribution that each cylinder makes to engine operation. If a cylinder is not contributing at the same level as the other cylinders, the computer sends a two digit code to the Code Reader that identifies that particular cylinder (see code description below).
 - If all cylinders are contributing equally, the computer sends a pass code (code 90) to the Code Reader to indicate that the system is OK, and that all cylinders are contributing equally.

Cylinder Balance Test Code Definitions

CODE	CODE DEFINITION
10	Cylinder #1 has a problem
20	Cylinder #2 has a problem
30	Cylinder #3 has a problem
40	Cylinder #4 has a problem
50	Cylinder #5 has a problem
60	Cylinder #6 has a problem
70	Cylinder #7 has a problem
80	Cylinder #8 has a problem
90	System is OK, all cylinders are contributing equally

NOTE: *The severity of an improperly contributing cylinder may be anywhere from mild to no contribution at all. In order for the computer to determine the severity of an improperly contributing cylinder, the Cylinder Balance Test may have to be consecutively repeated up to three times*

- The Cylinder Balance Test can be repeated by pressing and releasing accelerator pedal (as described in step 6, on page 41) within two minutes after the last cylinder balance code is retrieved.

Use the **A**, **B**, **C**, and **D** examples in the "TEST RESULTS CHART" to determine the meaning of the test results. The chart uses the #2 cylinder as an example, but the procedures are the same for any cylinder.

TEST RESULTS CHART

	TEST RESULTS			TEST DEFINITION	PROBLEM INDICATION	POSSIBLE CAUSE
	1st	2 nd	3rd			
A	90	*	*	System passed 1st test	System passed. All cylinders are contributing equally.	• System OK
B	20	90	*	Fails 1st test Passes 2nd test	Weak cylinder, cylinder is firing, but not contributing the same as the others	<ul style="list-style-type: none"> • Bad spark plug wire or spark plug • Partially clogged injector or injector circuit problem • Mechanical problem - rings, valves, etc.
C	20	20	90	Fails 1st test Fails 2nd test Passes 3rd test	Same as above, but condition is more severe.	• Same as above, but the condition is more severe.
D	20	20	20	Fails 1st test Fails 2nd test Fails 3rd test	Very weak or dead cylinder	<ul style="list-style-type: none"> • Bad spark plug wire or spark plug • Open or shorts on injector circuit, clogged injector • Mechanical problem - rings valves, etc.

Test Results Chart (Examples) Explanation

- A:** If a code 90 is retrieved the 1st time the cylinder balance test is performed (example **A** in TEST RESULTS CHART), the system is OK, and no further testing is required. Proceed to step 8.

- B:** If a cylinder problem code (Code 20 in example **B** in TEST RESULTS CHART) is retrieved the 1st time the test is performed, repeat the test again. If the system passes the 2nd time (Code 90) the test is performed, testing is complete. Consult the Test Chart for "Problem Indication" and "Possible Cause", then proceed to step 8.
- In example **B**, the test results show that cylinder #2 failed the test the first time but passed the 2nd time, indicating that #2 cylinder is firing but not contributing the same as the other cylinders.
- C:** If a cylinder problem code (Code 20 in example **C** in TEST RESULTS CHART) is retrieved the 1st and 2nd time the test is performed, repeat the test for a 3rd time. If the system passes on the third time (Code 90), testing is complete. Consult the Test Chart for "Problem Indication" and "Possible Cause" and proceed to step 8.
- In example **C**, the test results show that cylinder #2 failed the 1st and 2nd tests but passed on the 3rd test. This indicates that the cylinder is firing but not contributing the same as the other cylinders. The test results also show that in example **C** the problem is more severe than in example **B**.
- D:** If a cylinder problem code (Code 20 in example **D** in TEST RESULTS CHART) is retrieved the 1st, 2nd and 3rd time the test is performed, testing is complete. Consult the Test Chart for "Problem Indication" and "Possible Cause", then proceed to step 8.
- In example **D**, the test results show that # 2 cylinder failed the 1st, 2nd and 3rd tests. This indicates that cylinder #2 is extremely weak or dead, and there is very little or no power contribution to engine operation coming from this cylinder.
- 8.** Turn the ignition off and disconnect the Code Reader from the test connectors. The Cylinder Balance Test results are now in the Code Reader's memory.
- 9.** To view the Cylinder Balance Codes stored in the Code Reader's memory, press the **ON/OFF** button to turn the Code Reader on, then press and release the **MEMORY** button; the first stored code will display. Continue pressing and releasing the **MEMORY** button to scroll through the stored codes until all the codes have been displayed.

NOTE: After the Cylinder Balance Test is done, the KOER Test Fault Codes will be saved in the Code Reader's memory together with Cylinder Balance fault codes. To distinguish between the KOER codes and Cylinder Balance codes, consult the "Cylinder Balance Test Code Description Chart" preceding. Cylinder Balance fault codes are two digit codes, and are defined by the following numbers: 10, 20, 30, 40, 50, 60, 70, 80 and 90. Cylinder Balance codes will be displayed after KOER Self-Test codes.

- If any cylinder codes were received, use "Code Description" and "Test Results Chart" as a guide and consult the vehicle's service manual to perform further testing and/or repairs.

Wiggle Test (EEC-IV Systems)

- Always observe safety precautions before and during testing process.
- **ALWAYS** check Code Reader battery before retrieving fault codes.
- Use this test to check for intermittent faults in some circuits.

Circuits Tested:

1984 & Newer - Air Charge Temp Sensor (ACT), Barometer Pressure Sensor (BP), Engine Coolant Temp Sensor (ECT), Exhaust Gas Oxygen Sensor (EGO), EGR Valve Position Sensor (EVP), Manifold Absolute Pressure (MAP), Throttle Position Sensor (TP), Vane Air Temp Sensor (VAT)

1985 & Newer - Vane Air Flow Sensor (VAF)

1986 & Newer - Pressure Feedback EGR Sensor (PFE)

1990 & Newer - Exhaust Gas Oxygen Sensor (EGO), Ignition Diagnostic Monitor (IDM) (DIS or Dual Plug DIS only), Idle Tracking Switch (ITS), Mass Air Flow Sensor (MAF)

1. Turn ignition off.
2. Press and release the **ON/OFF** button to turn the Code Reader "ON". Press the **TEST/HOLD** button to place the Code Reader on "Hold", then connect the Code Reader to the vehicle's test connectors.

- Both the large and small connectors must be connected.

3. Turn the ignition on. **DO NOT START THE ENGINE.**

- **For 1986 and older vehicles:** Wiggle test is now active. Proceed to step 4.
 - **For 1987 and newer vehicles:** Set Code Reader switch to **TEST**, then **HOLD**, then **TEST**. Wiggle test is now active. Proceed to Step 4.
4. Perform "Wiggle Test" on circuit.
 - Wiggle sensor, connector and wiring that needs to be tested; a code will display if a fault is detected.

***NOTE:** On some models, service codes are lost when the ignition is turned off.*
 5. Turn off ignition and disconnect Code Reader from test connectors.
 - Consult service manual and service any fault codes retrieved during Wiggle Test.

FAULT CODE DEFINITIONS FOR EEC-IV SYSTEMS CAR & TRUCK

IMPORTANT: *Retrieving and utilizing Diagnostic Trouble Codes (DTC's) for troubleshooting vehicle operation problems is only one part of an overall diagnostic strategy. **Never replace a part** based only on the Diagnostic Trouble Code Definition. Always consult the vehicle's service manual for more detailed testing instructions. Each DTC has a set of testing procedures, instructions and flow charts that must be followed to confirm the exact location of the problem. This type of information is found in the vehicle's service manual.*

Test Condition Key:

O = Key Off Engine Off (KOEO) code

R = Key ON Engine Running (KOER) code

C = Continuous Memory (CM) code

CODE	TEST CONDITION	FAULT CODE DEFINITION
11	O, R, C	System OK
12	R	RPM at idle out of range/high
13	R	RPM at idle out of range/low
14	C	Ignition profile pickup (PIP) circuit failure
14	C	Engine RPM sensor circuit fault (Diesel)
15	O	EEC (PCM) Read Only Memory (ROM) test failed

CODE	TEST CONDITION	FAULT CODE DEFINITION
15	C	Power Interruption to computer memory or EEC (PCM) Keep Alive Memory (KAM) test failed
15	O	Read Only Memory test failed
16	O	(Cars ONLY): Signal from Ignition Diagnostic Monitor (IDM) not received
16	R	RPM too low to perform HEGO (HO2S) test
16	R	Idle RPM high with ISC retracted
16	R	RPM above self test limit with ISC off
17	R	(Cars ONLY): RPM below self-test limit
17	R	Idle RPM low with ISC retracted
17	R	Idle RPM high with ISC retracted
18	R	SPOUT circuit open or Spark Angle Word (SAW) circuit failure
18	C	Loss of tachometer input/IDM circuit failure / SPOUT circuit grounded
19	O	Failure in EEC (PCM) internal voltage
19	R	(Cars ONLY): Erratic RPM signal at idle / too low
19	C	(Cars ONLY): Cylinder Identification (CID) sensor failure
19	O	Power processor check
21	O, R	Cooling Temperature sensor out of specified range or ECT out of range
22	O, R, C	Manifold Absolute Pressure (MAP) or BARO sensor out of range
23	O, R, C	(Cars ONLY): Throttle Position (TP) sensor signal out of range
23	O, R	(Trucks ONLY): Throttle Position (TP) sensor signal out of range
23	O, R	Fuel injector pump lever sensor input is out of self test range (Diesel)
24	O, R	Intake Air Charge Temperature (ACT, IAT) sensor or Vane Air Temperature (VAT) sensor out of range
24	C	Coil #1 primary circuit failure

CODE	TEST CONDITION	FAULT CODE DEFINITION
25	R	Knock not sensed during Dynamic Response Test
26	O, R	(Cars ONLY): Mass Air Flow (MAF) sensor or Vane Air Flow (VAF) sensor or Transmission Oil Temperature (TOT) sensor out of range
26	O, R	(Trucks ONLY): MAF sensor or circuit fault (4.0L models)
26	O, R	(Trucks ONLY): Transmission oil temperature sensor fault (ex. 4.0L)
27	C	(Cars ONLY): Vehicle speed sensor or EDIS fault
27	C	Coil #2 primary circuit failure
28	O, R	(Cars ONLY): Vane Air Temperature (VAT) sensor; EDIS or DIS fault
28	C	Loss of primary tachometer (IDM), right side
29	C	Insufficient input from the Vehicle Speed Sensor (VSS)
29	C	Insufficient input from programmable speedometer/odometer module
31	O, R, C	(Cars ONLY): EVP or PFE circuit below minimum voltage
31	O, R, C	(Trucks ONLY): EGR valve control sensor fault (ex. V8 models)
31	O, R	(Trucks ONLY): EVAP control system below minimum voltage
32	R	(Cars ONLY): EGR valve control system signal out of specification
32	R, C	(Cars ONLY): EGR valve not seated
32	R, C	(Trucks ONLY): EGR pressure feedback fault (1985-89 models)
32	O, R, C	(Cars ONLY): EVP voltage low (SONIC) or EPT circuit voltage low (PFE)
33	R, C	(Cars ONLY): EGR valve not opening properly
33	R, C	(Trucks ONLY): EGR valve fault / not closing properly / TPS fault (Diesel)

CODE	TEST CONDITION	FAULT CODE DEFINITION
34	R	(Cars ONLY): EGR valve not opening properly
34	O, R, C	(Cars ONLY): Insufficient EGR flow or EVP voltage high (SONIC) or PFE sensor voltage high or out of specification
34	O, R, C	(Trucks ONLY): EGR control circuit fault (ex. V8 models)
34	O, R, C	(Trucks ONLY): EVAP control system fault / voltage higher than closed limit (V8 models)
34	C, O, R	Defective EGR pressure transducer sensor
35	R	(Cars ONLY): RPM too low for EGR test (2.3L MAP)
35	O, R, C	(Cars ONLY): EVP/PFE voltage high
35	O, R, C	(Trucks ONLY): No EGE position signal, RPM low
35	O, R, C	(Trucks ONLY): EVAP control system fault (V8 models)
36	R	System indicates lean at idle
36	R	Insufficient RPM increase during speed control test
37	R	System indicates rich at idle
37	R	Insufficient RPM increase during speed control test
38	C	DC motor idle speed control / idle tracking throttle position sensor open circuit
39	C	(Cars ONLY): Automatic overdrive not operating properly (transmission failure)
41	R	HEGO (HO2S) sensor voltage low / system lean
41	C	HEGO (HO2S) sensor signal out of range / always lean
41	C	No HO2S switching detected
42	R	HEGO (HO2S) sensor voltage high / system rich
42	C	(Cars ONLY): HEGO (HO2S) sensor signal out of range / always rich

CODE	TEST CONDITION	FAULT CODE DEFINITION
42	C	No O2S switching detected
43	C	(Cars ONLY): Lean HEGO (HO2S) at wide open throttle
43	R, C	(Trucks ONLY): Throttle position sensor below idle spec (Diesel)
44	R	Thermactor air system fault
45	R	Thermactor air upstream
45	C	DIS coil pack circuit failure
46	R	Thermactor air is not bypassed
46	C	(Cars ONLY): DIS coil pack circuit failure
47	O	4 x 4 switch closed (E4OD)
47	R	(Cars ONLY): Vane air flow low at idle
47	C	Spark timing error
48	R	(Cars ONLY): Vane Air flow high at idle
48	C	(Cars ONLY): DIS coil pack circuit failure / left side
48	C	Loss of ignition diagnostic monitor LH side
48	C	Coil #3 circuit failure
49	C	(Cars ONLY): SPOUT signal problem
49	C	(Trucks ONLY): 1-2 shift error
51	O, C	ECT sensor out of range indicated / circuit open
52	O	(Cars ONLY): PSPS (PSP) circuit open
52	R	(Cars ONLY): PSPS (PSP) circuit out of range
52	O, R	(Trucks ONLY): Power steering pressure switch open
53	O, C	Throttle Position sensor above maximum voltage
53	C, O	Fuel injector pump lever sensor input is greater than self test
54	O, C	Intake Air charge temperature sensor circuit open; vane air flow sensor out of range
55	R	(Cars ONLY): Open connection in ignition key circuit

CODE	TEST CONDITION	FAULT CODE DEFINITION
55	R	(Trucks ONLY): Charging system fault
56	O, C	(Cars ONLY): Mass or vane air flow sensor above maximum voltage transmission sensor failure
56	C	(Trucks ONLY): Mass Air Flow sensor fault (voltage higher than normal) (4.0L models)
56	O, C	(Trucks ONLY): Transmission oil temperature sensor fault (ex. 4.0L models)
57	O	(Cars ONLY): Octane adjust circuit grounded
57	C	(Cars ONLY): AXOD Neutral Pressure Switch (NPS) circuit fault; circuit open
58	O, C	(Cars ONLY): Vane air control circuit fault; circuit open
58	R	(Trucks ONLY): Idle tracking switch circuit fault
59	O	(Cars ONLY): AXOD 4/3 pressure switch circuit failure or idle adjust circuit grounded (2.9L MAP)
59	O, C	(Cars ONLY): AXOD 4/3 pressure switch circuit failure or 2-3 shift error (E4OD)
59	O, C	(Cars ONLY): Low speed fuel pump circuit failure
59	C	(Trucks ONLY): Transmission throttle pressure switch circuit fault (1985 through 1988 models)
59	C	(Trucks ONLY): 2-3 shift error (1989 models)
61	O, C	Engine coolant temperature sensor fault or circuit grounded
62	O	(Cars ONLY): AXOD 4/3 or 3/2 pressure switch circuit failure; circuit closed
62	C	(Cars ONLY): Transmission clutch fault (E4OD)
62	O, R	(Trucks ONLY): Transmission 4/3 circuit fault

CODE	TEST CONDITION	FAULT CODE DEFINITION
63	O, C	Throttle Position (TP) circuit fault, below minimum voltage
63	C, O	Fuel injection pump lever sensor input is less than self test minimum (Diesel)
64	O, C	ACT (IAT)/vane air temperature sensor fault or circuit grounded
65	R	Overdrive Cancel Switch not changing state (E4OD); transmission fault
65	R	(Trucks ONLY): Charging system (1985 through 1988 models)
65	C	(Cars ONLY): Fuel injector never went closed loop
66	R, C	(Cars ONLY): VAF/mass air flow sensor fault, below minimum voltage
66	C	(Trucks ONLY): MAF circuit below voltage (4.0L models)
66	O, C	TOT sensor signal input below self-test minimum, or vane air flow circuit below minimum (E4OD)
67	O	Neutral Pressure Switch (NPS) circuit failure, circuit open (3.0L MAP, 3.0L MAF-SFI, 3.8L SFI)
67	C	(Cars ONLY): Clutch switch circuit failure
67	C	(Trucks ONLY): Air conditioning compressor clutch switch fault
67	O, R	(Cars ONLY): Neutral Drive Switch (NDS) circuit failure, circuit open; or A/C input high
67	O, C	(Cars ONLY): Manual Lever Position (MLP) sensor out of range; or A/C input high (4.9L MAP, 5.8L MAP)
68	O, C	(Cars ONLY): Vane air temperature circuit grounded
68	O, R, C	(Cars ONLY): Transmission temperature switch circuit failure; circuit open
68	C	(Trucks ONLY): Transmission oil temperature over heat

CODE	TEST CONDITION	FAULT CODE DEFINITION
68	O	(Trucks ONLY): Idle tracking switch (1985 through 1989 models)
69	O	(Cars ONLY): AXOD 4/3 or 3/2 pressure switch circuit failure; circuit closed
69	O	(Trucks ONLY): Vehicle Speed Sensor fault
69	C	AXOD 4/3 or 3/2 pressure switch circuit failure, circuit open; or 3-4 shift error (E4OD)
70	C	(Cars ONLY): ECM failure
71	C	(Cars ONLY): ECM reinitialization detected on Cluster Control Assembly (CCA) circuit failure
71	C	Idle tracking switch closed on pre-position
72	C	(Cars ONLY): System power circuit fault; Message Center Control Assembly (MCCA) circuit failure
72	R	MAP, MAF or BP sensor out of range during Dynamic Response Test
73	O	(Cars ONLY): Insufficient throttle position change
73	R	(Cars ONLY): Throttle Position Sensor fault / insufficient range
73	O, R	(Trucks ONLY): Insufficient Throttle Position change during Dynamic Response Test
74	R	Brake On/Off (BOO) switch fault; not actuated
75	R	Brake On/Off (BOO) switch fault / closed circuit
76	R	(Cars ONLY): Vane air flow sensor fault / insufficient range during Dynamic Response Test
77	R	Operator error during Dynamic Response Test / Wide Open Throttle not sensed
78	C	(Trucks ONLY): Time delay relay fault
79	O	(Cars ONLY): Air Conditioner "ON" during Self-Test / defrost on

CODE	TEST CONDITION	FAULT CODE DEFINITION
79	-	(Trucks ONLY): Air conditioner on while performing test
81	O	Air diverter solenoid fault, intake air control circuit fault / air injection diverter
82	O	Air diverter solenoid circuit fault or supercharger bypass circuit fault
82	O	Integrated relay control module
83	O	EGR solenoid circuit fault (2.3L MAP)
83	O	(Cars ONLY): Cooling fan circuit fault
83	O, C	(Cars ONLY): Low speed fuel pump relay circuit fault, circuit open (3.0L MAF-SFI)
83	O	EVP/EGRC/EGRV
84	O, R	(Cars ONLY): EGR vacuum regulator circuit failure
84	O	(Trucks ONLY): EGR vent fault
85	O, R	(Cars ONLY): Canister Purge Solenoid circuit failure
85	C	(Cars ONLY): Adaptive fuel limit reached - lean
85	O	(Trucks ONLY): Canister purge circuit failure
85	O	Shift solenoid 3/4 - 4/3
86	O	Adaptive fuel limit reached or 3-4 shift solenoid circuit failure
86	C	(Cars ONLY): Adaptive fuel limit reached - rich
87	O, R, C	(Cars ONLY): Fuel pump primary circuit fault
87	O	(Trucks ONLY): Primary fuel pump circuit failure
88	O	(Cars ONLY): Cooling fan circuit fault
88	O	(Trucks ONLY): Choke relay out of range
88	C	Dual plug input control failure
88	O	Shift solenoid 3/4 - 4/3
89	O	AXOD Lock-Up Solenoid (LUS) circuit failure or Clutch Converter Override (CCO) circuit failure

CODE	TEST CONDITION	FAULT CODE DEFINITION
89	O	Exhaust heat control
91	O	Shift Solenoid 1 (SS1) circuit failure
91	R	(Cars ONLY): HEGO (HO2S) sensor voltage low / system lean
91	C	(Cars ONLY): HEGO (HO2S) sensor signal out of range /always lean
92	O	Shift Solenoid 2 (SS2) circuit failure
92	R	(Cars ONLY): HEGO (HO2S) sensor voltage high / system rich
93	O	(Cars ONLY): Throttle position sensor signal input low at maximum DC motor extension or Converter Clutch Control (CCC) circuit failure
93	O	(Trucks ONLY): Coast clutch circuit failure
94	O	Converter Clutch Control (CCC) circuit failure
94	R	(Cars ONLY): Air diverter solenoid circuit fault
95	O, C	Fuel pump secondary circuit fault
96	O, C	Fuel pump secondary circuit fault / high speed fuel pump relay open
97	O	Overdrive Cancel Indicator Light (OCIL) circuit failure
98	O	Electronic Pressure Control (EPC) driver failure in processor
98	R	(Cars ONLY): Hard fault is present - FMEM mode
98	R	(Trucks ONLY): Test failure, hard fault repeat sequence (1985 through 1988)
99	O, C	Electronic Pressure Control (EPC) circuit failure
99	R	(Cars ONLY): EEC system has not learned to control idle
111	O, R, C	System PASS
112	O, C	(Cars ONLY): Intake Air Temperature (IAT) sensor circuit below minimum voltage / 254°F indicated

CODE	TEST CONDITION	FAULT CODE DEFINITION
112	O, C	(Trucks ONLY): Air charge temperature sensor below minimum voltage
113	O, C	Intake air charge temperature sensor above maximum voltage / -40° indicated
114	O, R	Air charge temperature sensor higher or lower than expected voltage
116	O, R	Engine coolant temperature higher or lower than expected
117	O, C	Engine coolant temperature sensor below minimum voltage / 254° F indicated
118	O, C	Engine coolant temperature sensor above maximum voltage / 0 to -40° F indicated
121	O, R, C	Closed throttle voltage higher or lower than expected
122	O, C	Throttle Position sensor below minimum voltage
123	O, C	Throttle Position sensor above maximum voltage
124	C	Throttle Position sensor voltage above normal
125	C	Throttle Position sensor voltage below normal
126	O, R, C	Manifold absolute pressure (MAP) or barometric sensor (BARO) above or below normal
126	C	Cylinder identification circuit failure
128	R	(Cars ONLY): Manifold absolute pressure sensor failure/ vacuum hose disconnected or damaged
128	C	(Trucks ONLY): Manifold absolute pressure sensor / vacuum hose disconnected or damaged
129	R	Insufficient Mass Air Flow (MAF) change during dynamic response test
136	R	HEGO (HO2S) sensor fault, always lean
137	R	HEGO (HO2S) sensor fault, always rich
138	R	Cold start injector flow insufficient

CODE	TEST CONDITION	FAULT CODE DEFINITION
139	C	(Cars ONLY): HEGO (HO2S) sensor switch fault
141	R	Flexible fuel control / fuel system lean
144	C	HEGO (HO2S) sensor switch fault
157	C	Mass Air Flow sensor fault, low voltage
158	O, C	Mass Air Flow sensor fault, high voltage
159	O, R	Mass Air Flow sensor fault, above or below normal
167	R	Throttle Position sensor fault during dynamic response test
171	C	(Cars ONLY): HEGO (HO2S) sensor fault/not switching, or fuel system at adaptive limits
171	C	(Trucks ONLY): HEGO (HO2S) sensor fault/not switching
172	R, C	HEGO (HO2S) sensor fault/lean
173	R, C	HEGO (HO2S) sensor fault/rich
174	C	(Cars ONLY): HEGO switching time slow
175	C	(Cars ONLY): HEGO (HO2S) sensor fault/not switching, or fuel system at adaptive limits
175	C	(Trucks ONLY): HEGO (HO2S) sensor fault/not switching
176	C	HEGO (HO2S) sensor fault/always lean
176	R*	Insufficient TP change during no oxygen sensor switch detected
177	C	HEGO (HO2S) sensor fault/always rich
177	*	No oxygen sensor switch detected
178	C	(Cars ONLY): HEGO switching time slow
179	C	(Cars ONLY): Fuel system at lean adaptive limit at partial throttle / system rich
179	C	(Trucks ONLY): HEGO (HO2S) sensor fault unable to switch / rich during part throttle
181	C	(Cars ONLY): Fuel system at rich adaptive limit at partial throttle / system lean

CODE	TEST CONDITION	FAULT CODE DEFINITION
181	C	(Trucks ONLY): HEGO (HO2S) sensor fault unable to switch / lean during part throttle
182	C	Fuel system at lean adaptive limit at idle / system rich
183	C	Fuel system at rich adaptive limit at idle / system lean
184	C	Mass Air Flow sensor above normal
185	C	Mass Air Flow sensor below normal
186	C	Fault in injector pulse width circuit / high
187	C	Fault in injector pulse width circuit / low
188	C	(Cars ONLY): Fuel system at lean adaptive limit at partial throttle / system rich
188	C	(Trucks ONLY): HEGO (HO2S) sensor fault unable to switch / rich during part throttle
189	C	(Cars ONLY): Fuel system at rich adaptive limit at partial throttle / system lean
189	C	(Trucks ONLY): HEGO (HO2S) sensor fault unable to switch / lean during part throttle
190	*	Adaptive fuel lean limit reached at "Idle, system rich"
191	C	(Cars ONLY): Fuel system at lean adaptive limit at idle / system rich
192	C	(Cars ONLY): Fuel system at rich adaptive limit at idle / system lean
193	O	(Cars ONLY): Flexible fuel sensor circuit fault
211	C	Profile Ignition Pickup (PIP) circuit fault
212	C	Loss of ignition diagnostic monitor signal/SPOUT circuit grounded
213	R	SPOUT circuit open
214	C	Cylinder identification circuit failure
215	C	DIS fault ignition system - coil #1
216	C	DIS fault ignition system - coil #2

CODE	TEST CONDITION	FAULT CODE DEFINITION
217	C	DIS fault ignition system - coil #3
218	C	Loss of Ignition Diagnostic Monitor (IDM) signal/left side
219	C	(Cars ONLY): SPOUT signal defaulted to 10° BTDC / SPOUT circuit open
221	C	Spark timing error
222	C	Distributorless Ignition System - loss of right side ignition Diagnostic Monitor (IDM) signal
223	C	Distributorless Ignition System - loss of dual plug inhibit (DPI) control
224	C	Erratic IDM input to processor
224	C	(Trucks ONLY): SPOUT circuit ground/coil 1, 2, 3 or 4
225	R	Knock sensor fault during dynamic response test
226	C	(Cars ONLY): Ignition diagnostic Monitor (IDM) signal not received
226	C	(Trucks ONLY): Electronic Distributorless Ignition System (EDIS) problem - Crankshaft Position Sensor (CPS) problem
227	*	Crank position sensor
232	C	(Trucks ONLY): Electronic Distributorless Ignition System (EDIS) Coil 1, 2, 3 or 4 circuit fault
233	*	Spark angel pulse width error
238	C	PCM detect coil 4 primary circuit failure
239	*	Crank position signal received with engine off
241	*	EDIS to EEC processor ignition diagnostic module pulse width transmission error
242	*	Operating in DIS failure mode
243	*	Secondary circuit failure
244	R	Cylinder identification circuit failure
311	R	Thermactor air system/fault during engine run self-test

CODE	TEST CONDITION	FAULT CODE DEFINITION
312	R	Thermactor air system/fault during engine run self-test
313	R	Thermactor air system/air not bypassed during self-test
314	R	(Cars ONLY): Thermactor air system/fault during engine run self-test / left side
326	R, C	(Cars ONLY): EGR sensor circuit voltage lower than expected
327	O, R, C	EGR valve position circuit below minimum voltage
327	*	EVP/EPT circuit below minimum voltage
328	O, R, C	EGR closed valve voltage lower than expected
332	R, C	Insufficient EGR flow detected
334	O, R, C	EGR closed valve voltage high
335	O	EGR sensor circuit voltage higher or lower than expected during self-test
336	R, C	EGR sensor circuit voltage higher than expected
336	R, C	(Trucks ONLY): Exhaust pressure high
337	O, R, C	EGR sensor circuit above maximum voltage
338	C	(Cars ONLY): Engine Coolant temperature (ECT) lower than expected
339	C	(Cars ONLY): Engine Coolant temperature (ECT) higher than expected
341	R	(Cars ONLY): Octane adjust service pin open
381	C	Erratic A/C compressor clutch cycling
411	R	Cannot control RPM during KOER low RPM check
412	R	Cannot control RPM during KOER high RPM check
415	*	Idle speed control system at minimum learning limit
416	*	Idle air control system at maximum learning limit

CODE	TEST CONDITION	FAULT CODE DEFINITION
452	R	(Cars ONLY): Vehicle Speed Sensor (VSS) signal fault
452	C	(Trucks ONLY): Vehicle Speed Sensor (VSS) signal fault
453	*	Servo leaking down during test
454	*	Servo leaking up during test
455	*	Insufficient RPM increase during speed
456	*	Insufficient RPM decrease during test
457	*	Speed control command switches circuit not functioning
458	*	Speed control command switches stuck or circuit control
459	*	Speed control ground circuit open
511	O	Read Only Memory (ROM) test failure
512	C	Keep Alive Memory (KAM) test failure
513	C	PCM internal voltage failure
519	O	Power Steering Pressure Switch circuit open
521	R	Power Steering Pressure Switch circuit fault
522	O	Vehicle not in Park or Neutral during KOEO
524	O, C	(Cars ONLY): Low speed fuel pump circuit open - battery to ECA
525	O	(Cars ONLY): Vehicle was in gear or A/C on during self-test
526	O	(Cars ONLY): Neutral Pressure Switch NPS (PNP) circuit closed; A/C on
527	O	(Cars ONLY): Neutral Drive Switch NDS (PNP) circuit open; A/C on
528	C	Clutch switch circuit fault
529	C	(Cars ONLY): Data communications link or EEC circuit fault
532	*	Cluster control assembly circuit failure
533	C	(Cars ONLY): Data communications link or EIC circuit fault

CODE	TEST CONDITION	FAULT CODE DEFINITION
536	R, C	Brake On/Off (BOO) circuit not activated during KOER
538	R	Insufficient RPM change during KOER Dynamic Response Test/
538	R	(Trucks ONLY): invalid cylinder balance test due to throttle movement during test
539	O	A/C on/Defrost on during KOEO
542	O, C	Fuel pump secondary circuit fault
543	O, C	Fuel pump secondary circuit fault
551	O	Idle Air Control solenoid circuit fault
552	O	Thermactor air bypass solenoid circuit fault
552	*	Air management circuit 1 failure
553	O	Thermactor air diverter solenoid circuit fault
553	*	Air management circuit 2 failure
554	O	(Cars ONLY): Fuel Pressure Regulator Control (FPRC) circuit failure
554	*	Fuel pressure regulator control circuit failure
555	*	Supercharger bypass solenoid circuit failure
556	O, C	Fuel pump relay primary circuit fault
557	O, C	Fuel pump primary circuit failure
558	O	EGR valve regulator solenoid circuit fault
559	O	(Cars ONLY): Air conditioning ON relay circuit failure
562	*	Auxiliary electric fan circuit failure
563	O	(Cars ONLY): High Speed Electro Drive Fan circuit fault
564	O	(Cars ONLY): Electro Drive Fan circuit fault
565	O	Canister purge solenoid circuit fault
566	O	3-4 shift solenoid circuit failure
567	*	Speed control vent circuit failure
568	*	Speed control vacuum circuit failure

CODE	TEST CONDITION	FAULT CODE DEFINITION
569	O	(Trucks ONLY): Auxiliary Canister Purge (AUX-CANP) circuit failure
571	O	EGR circuit failure
572	O	EGR circuit failure
578	C	A/C pressure sensor circuit
579	C	Insufficient A/C pressure change
581	C	Power to fan circuit over current
582	O	Fan circuit open
583	C	Power to fuel pump over current
584	C	Power ground circuit open
585	C	Power to A/C clutch over current
586	C	A/C clutch circuit open
587	C, O	Vehicle control relay module communication failure
617	C	Transmission problem (1-2 shift error)
618	C	Transmission problem (2-3 shift error)
619	C	Transmission problem (3-4 shift error)
621	O	Shift Solenoid #1 circuit fault
622	O	Shift Solenoid #2 circuit fault
623	C, O	Transmission control indicator lamp circuit failure
624	O, C	Electronic Pressure Control solenoid circuit fault
625	O	Electronic Pressure Control solenoid circuit fault
625	C, O, R	Hard fault is present
626	O	Coast Clutch solenoid circuit fault
627	O, C	Converter Clutch Control solenoid circuit fault
628	O, C	Excessive converter clutch slippage
628	O	(Cars ONLY): Lock-up solenoid failure
629	O	Converter clutch solenoid circuit fault or lock-up solenoid circuit fault
631	O	Overdrive Transmission Cancel Indicator Light circuit fault

CODE	TEST CONDITION	FAULT CODE DEFINITION
632	R	Overdrive Transmission Cancel Switch/ no action during self engine run test
633	O	4 x 4 switch is closed
634	C	Manual Lever Position sensor voltage higher or lower than expected or A/C on
636	O, R	Transmission Oil Temperature higher or lower than expected
637	O, C	Transmission Oil Temperature circuit above maximum voltage
638	O, C	Transmission Oil Temperature circuit below minimum voltage
639	R, C	Insufficient input from transmission speed sensor
641	O	(Cars ONLY): Shift Solenoid #3 circuit fault
643	O, C	(Cars ONLY): Converter Clutch Control (CCC) circuit failure
645	C	(Cars ONLY): Incorrect gear ratio-first gear
646	C	(Cars ONLY): Incorrect gear ratio-second gear
647	C	(Cars ONLY): Incorrect gear ratio-third gear
648	C	(Cars ONLY): Incorrect gear ratio-fourth gear
649	C	(Cars ONLY): Electronic Pressure Control Circuit solenoid higher or lower than expected
651	C	(Cars ONLY): Electronic Pressure Control circuit solenoid failure
652	O	(Cars ONLY): Modulated Lock-Up Torque Converter Clutch Solenoid circuit fault
652	C	Transmission over temp condition
654	O	Not in "park" during KOEO Self-test
655	C	(Trucks ONLY): Manual Lever Position (MLP) sensor indicating not in NEUTRAL during Self-Test

CODE	TEST CONDITION	FAULT CODE DEFINITION
656	C	Converter Clutch Control (CCC) continuous slip error
659	R	High vehicle speed in park indication
662	O	Shift solenoid 2 circuit
667	C, O	Transmission range sensor circuit below maximum voltage
668	C, O	Transmission range sensor circuit above maximum voltage
675	O, R	Transmission range sensor circuit voltage out of range
675	C	Cluster center control circuit failed dynamic response test
998	R	Operating in failure mode
NO CODES		Unable to initiate Self-Test or unable to output Self-Test codes

* Test condition not available

RETRIEVING FAULT CODES FROM MCU SYSTEMS

Preliminary Procedures

The following "Preliminary Procedures" MUST be performed before the actual KOEO and/or KOER Self Tests are performed.

- Always observe safety precautions before and during testing process.
 - Fix any known mechanical problem before this test.
 - A voltmeter is required to perform this test.
1. Idle engine until it reaches normal operating temperature.
 2. While engine is running, use a voltmeter to check voltages between the choke cap and engine ground. For battery powered choke, voltage should be approximately 12 volts. For alternator powered choke, voltage should be approximately 7.5 volts.
 3. Turn ignition off.
 4. If your vehicle has one or more of the following configurations perform the Set-Up Procedures as described below:

- **In-Line 4 and In-Line 6 with canister control valve:** Remove hose from connector port B. Reconnect after testing is completed.
- **V-6 and V-8: Remove PCV valve:** Reconnect after testing is completed.
- **2.3L with GK code:** Locate the anti-backfire vacuum switch tee behind the MCU module and remove the cap. Reconnect after testing is completed.
- **2.3L with EGR vacuum load control valve:** Cover vacuum valve vent holes with tape. Remove the tape after testing is completed.
- **4.2L with vacuum delay valve:** Uncap restrictor in Thermactor Air Diverter (TAD) solenoid vacuum line. Reconnect after testing is completed.
- **5.8L with vacuum delay valve:** Uncap restrictor in Thermactor Air Bypass (TAB) solenoid vacuum line. Reconnect after testing is completed.

KEY ON ENGINE OFF (KOE0) SELF TEST (MCU SYSTEMS)

- The "Preliminary Procedures" (page 65) must be completed before performing the KOE0 Self Test
 - Always observe safety precautions before and during testing process.
 - **ALWAYS** check Code Reader battery before retrieving fault codes.
 - Fix any known mechanical problems before this test.
1. Warm-up engine to normal operating temperature before this test.
 2. Turn ignition off.
 3. Turn the Code Reader switch to **OFF** then connect it to the vehicle's test connector.
 - MCU Systems have one six pin connector **only**.

4. Press and release the **ON/OFF** button to turn the Code Reader "ON".

- Three zeros should be visible on the display at this time.



5. Press and release the **TEST/HOLD** Button to put the code reader in TEST mode.

6. Turn on ignition. **DO NOT START THE ENGINE.**

- The display will show a "Triangle" Icon on the lower right hand corner of the screen to indicate that the code reader is in test mode.



7. After about 4 to 30 seconds (it may take longer on some vehicles) the computer will start sending the test results to the Code Reader in the form of numerical codes.

- A square icon on the right hand side of the screen will appear and flash each time the Code Reader receives a code, and then the code will be displayed on the Code Reader's screen.



- A small "O" will be visible in the upper right hand corner of the screen to indicate that the code being received is a KOEO Self Test fault code.

8. After all the KOEO Self Test codes are received (wait until the flashing square icon no longer appears on the screen for 30 consecutive seconds to ensure that all the codes have been retrieved), turn the Code Reader off.

- The codes retrieved are now stored in the Code Reader's memory.

9. Turn the ignition off and disconnect the Code Reader from the vehicle's test connector. The codes retrieved are now stored in the Code Reader's memory.

10. To view codes stored in the Code Reader's memory, press the **ON/OFF** button to turn the Code Reader on, then press and release the **MEMORY** button; the first stored code will display. Continue pressing and releasing the **MEMORY** button to scroll through the stored codes until all the codes have been displayed.

NOTE: All retrieved codes will stay in the Code Reader's memory and will only clear from the Code Reader's memory if the Self Test procedure is performed again (codes from a prior test will clear automatically when new Self Test is performed) or if batteries are removed from the Code Reader.

11. Go to page 72 for "FAULT CODE DEFINITION FOR MCU SYSTEMS". Use the code definitions as a guide and follow the manufacturer's service procedures in the vehicle's service manual to troubleshoot and repair faults.
 - All KOEO Self Test codes that are received by the Code Reader during the KOEO Self Test represent problems that are present now (at the time the test is performed). The related vehicle problems that cause these codes to set must be repaired using the procedures described in the vehicle's service manual.
12. After all repairs have been completed, repeat the KOEO Self Test to verify the repair was successful. Do not proceed to the KOER Self test until all the problems that caused any KOEO fault codes to set are repaired.

KEY ON ENGINE RUNNING (KOER) SELF TEST (MCU SYSTEMS)

IMPORTANT: The "Preliminary Procedures" (page 66) and the "KOEO Self Test" (page 67) must be completed first, before the KOER Self-Test is performed; otherwise test results might be invalid.

When the KOER Self Test is activated, it tests the operation of the actuators, relays, switches, etc. under actual engine operating conditions. During this test, the computer sends electrical signals to some of these devices and waits for their response to see if its commands are carried out properly.

If the response from any of these devices is incorrect, that particular device fails the test and the computer assigns a numerical Fault Code that is specific to the device, circuit and/or system where the problem was detected. All faults detected during the KOER Self Test are sent to the Code Reader as numerical fault codes for further evaluation.

- Always observe all safety precautions before and during the testing process.
- **ALWAYS** check the Code Reader's batteries before conducting the test.

NOTE: For vehicles with 2.3L HSC (High Swirl Combustion) engines: Locate vacuum tee and restrictor in the thermactor vacuum control line, and uncap during KOER Test Reconnect after testing is completed.

1. Turn ignition off.
2. Press the **ON/OFF** Button to turn Code Reader OFF, then connect the Code Reader to the vehicle's test connector.

- MCU systems are equipped with only one 6-pin connector (see page 18 for details).

3. Turn Code Reader ON, then press and release **TEST/HOLD** button to place the Code Reader in TEST mode.

- Three zeros should be visible on the display at this time.



4. Start the engine.

- **For In-Line 4 And In-Line 6 engines, do the following:**

Gradually increase engine speed to 3,000 RPM and hold this speed until codes appear on the Code Reader's display.

When codes begin to appear on the Code Reader's display, return engine speed to idle. Proceed to step 5.

- **For V-6 or V-8 engines, do the following:**

Gradually increase engine speed to 2,500 RPM and hold for 2 minutes, then reduce engine speed back to idle.

Turn off engine. Restart engine and let idle. Proceed to step 5.

5. Read diagnostic trouble codes on the Code Reader's display.

- A square icon on the right hand side of the screen will appear and flash each time the Code Reader receives a code, and then the code will be displayed on the Code Reader's screen.

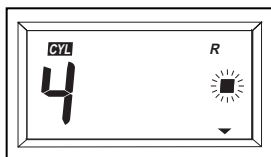

- The first code displayed by the Code Reader is the Cylinder Identification (ID) Code. The cylinder ID code identifies the number of cylinders of the vehicle that is under test.
- A small "R" will show in the upper right hand corner of the display to indicate that the code being retrieved is a Key On Engine Running (KOER) code.

NOTE: If all the procedures are followed and the Code Reader fails to work, refer to "Troubleshooting" on page 75.

6. Test the knock sensor (if applicable) after the cylinder ID code is transmitted. Place a steel shaft near the bottom of the knock sensor (not on the sensor). With a light hammer, knock slowly on the end of the shaft for 15 seconds.

NOTE: For vehicles equipped with knock sensors: Code 25 may display if the knock sensor test in step 6 is not performed.

7. If any problems are detected on any components or circuits as they are being tested, a numerical code (Diagnostic Trouble Code) will be sent to the Code Reader.
8. After all the KOER Self Test Codes are received by the Code Reader (wait until the flashing square icon no longer appears on the screen for 30 consecutive seconds to ensure that all the codes have been retrieved), turn the Code Reader off.
9. Turn the engine off and disconnect the Code Reader from the vehicle's test connector. The codes received are now stored in the Code Reader's memory.
10. To view codes stored in the Code Reader's memory, press the **ON/OFF** button to turn the Code Reader on, then press and release the **MEMORY** button; the first stored code will display. Continue pressing and releasing the **MEMORY** button to scroll through the stored codes until all the codes have been displayed.

NOTE: All retrieved codes will stay in the Code Reader's memory and will only clear from the Code Reader's memory if the Self Test procedure is performed again (codes from a prior test will clear automatically when new Self Test is performed) or if batteries are removed from the Code Reader.

- Refer to page 72 for "Fault Code Definitions for MCU Systems". Use the code definition as a guide and follow the manufacturer's service procedures in the vehicle's service repair manual to troubleshoot and repair faults.
 - All KOER codes that are received by the Code Reader during the KOER Self test represent problems that are present now (at the time the test is performed). The related vehicle problems that cause these codes to set must be repaired using the procedures described in the vehicle's repair manual.
11. After all repairs have been completed, repeat the KOER Self Test to confirm the repair was successful.

FAULT CODE DEFINITION FOR MCU SYSTEMS CAR & TRUCK

CODE	FAULT CODE DEFINITION
11	<p>NOTE: "High Altitude" refers to vehicles computer adjusted for high elevations.</p> <p>I-4 (All except High Altitude): System OK I-4 (High Altitude only): Altitude (ALT) circuit is open. I-6: System OK. V-6 (All except High Altitude): System OK. V-6 (High Altitude only): Altitude (ALT) circuit is open. V-8 (All except High Altitude): System OK. V-8 (High Altitude only): Altitude (ALT) circuit is open.</p>
12	V-8: RPM out of range (throttle kicker).
25	V-8: Knock Sensor (KS) signal not detected.
33	I-4, I-6, V-6: Key On Engine Running (KOER) Self-Test not initiated.
41	All Engines: Exhaust Gas Oxygen sensor: voltage signal lean (low).
42	All Engines: Exhaust Gas Oxygen sensor: voltage signal rich (high).
44	All Engines: Oxygen sensor signal indicates Rich - excessive fuel, restricted air intake — or — Inoperative Thermactor System
45	All Engines: Thermactor air flow going upstream to exhaust manifold.

CODE	FAULT CODE DEFINITION
46	All Engines: Thermactor Air System unable to bypass.
51	I-4: Low or Mid Temperature Switch is open when engine is hot. I-6: Low or Mid Temperature Vacuum Switch is open when engine is hot. V-6: Hi or Hi/Low Vacuum Switch is always open. V-8: Hi or Hi/Low Vacuum Switch is always open.
52	I-4 (car): Idle Tracking Switch (ITS) - voltage does not change from closed to open throttle. I-4 (truck): Idle/Decel Vacuum Switch open constantly. I-6: Wide Open Throttle Vacuum Switch is open constantly.
53	I-4: Wide Open Throttle Vacuum Switch open constantly. I-6: CROWD Vacuum Switch open constantly. V-6: Dual Temperature Switch is open constantly. V-8: Dual Temperature Switch is open constantly.
54	V-8: Mid Temperature Switch is open constantly.
55	V-8: Mid Vacuum Switch is open constantly.
56	I-6: Closed Throttle Vacuum Switch is open constantly.
61	V-8: Hi/Low Vacuum Switch is closed constantly.
62	NOTE: "High Altitude" refers to vehicles computer adjusted for operation at high elevations. I-4 (car): Idle Tracking Switch is closed at idle. I-4 (truck): Idle/Decel Vacuum Switch is closed constantly. I-6: Wide Open Throttle Vacuum Switch is closed constantly. V-6 (All except High Altitude): Altitude circuit is open. V-6 (High Altitude only): System OK. V-8 (All except High Altitude): Altitude (ALT) circuit is open. V-8 (High Altitude only): System OK.
63	I-4: Wide Open Throttle Vacuum Switch is closed constantly. I-6: CROWD Vacuum Switch is closed constantly.
64	NOTE: "High Altitude" refers to vehicles that are computer adjusted for high elevation operation. I-4: (All except High Altitude): Altitude circuit is open. I-4: (High Altitude only): System OK. V-6: Mid Vacuum Switch is closed constantly. V-8: Mid Vacuum Switch is closed constantly.

CODE	FAULT CODE DEFINITION
65	<p><i>NOTE:</i> "High Altitude" refers to vehicles that are computer adjusted for high elevation operation.</p> <p>I-4: (All except High Altitude): Altitude circuit is open. I-4: (High Altitude Only): System OK. V-6: Mid Vacuum Switch is closed constantly. V-8: Mid Vacuum Switch is closed constantly.</p>
66	I-6: Closed Throttle Vacuum Switch is closed constantly.

CODE READER TROUBLESHOOTING GUIDE

If all procedures are followed and the Code Reader will not retrieve codes when performing the Key On Engine Off (KOEO) Self Test, check the following:

1. Code Reader's batteries, change batteries as required.
2. Check the vehicles Test Connector pins for corrosion and clean as necessary.

NOTE: *The Code Reader receives a ground signal from one of the pins of the vehicle's Test Connectors and uses it to signal the computer to initiate the Self-Tests. A problem in the vehicle's Test Connector ground pin or circuit will result in an improper ground being supplied to the code reader which will effect the code reader's ability to signal the computer to initiate the Self Test. If after performing the procedures in step one and two, the code reader still does not work proceed to EEC-IV Systems/ MCU Systems bellow (as applicable).*

EEC-IV Systems (most 1985-95 vehicles)

On some vehicles equipped with the EEC-IV Computer Systems the vehicle's Test Connector ground circuit may have a poor ground due to bad ground point connections, old and corroded wiring, poor connector to wire contacts etc. that will prevent the Code Reader from initiating the Self-Test. To alleviate this problem and allow the Code Reader to initiate the Self-Test, perform the following steps.

1. Disconnect the single pin Vehicle's Test Connector from the code reader (leave the six pin Test Connector connected to code reader).
2. Route a jumper wire from the vehicle's harness single pin Test Connector to the vehicle's battery negative post or to a clean spot in the vehicle's metal frame. See drawing.

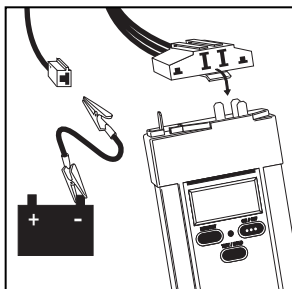

3. Proceed with KOEO Self Test as per KOEO instructions.

MCU Systems (Most 1981-84 vehicles)

The 6-pin MCU Test Connectors for some vehicle models are not equipped with a ground terminal at position "F". This terminal is required by the code reader to provide a ground signal to the vehicle's computer to initiate the Self-Test.

If no codes are displayed during the testing procedure, check the Test Connector for ground terminal at position "F". If no terminal is present at position "F",

connect a jumper wire from the open terminal on the Code Reader to the negative post of the battery or a bare clean spot in the vehicle's metal frame.

- If after performing all the troubleshooting procedures the code reader still will not work consult the vehicles service repair manual and/or contact the service department. See page 89 for service information.

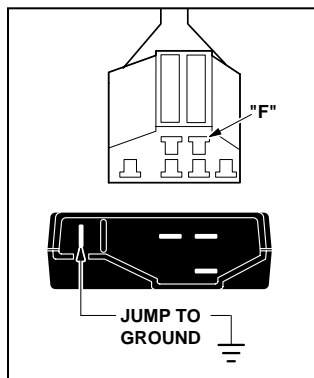

INTRODUCTION

The Society of Automotive Engineers has issued a Standard (SAE J1930) for Electrical/Electronic Systems Diagnostic Terms, Definitions, Abbreviations, and Acronyms. However, at the present time, this Standard is not in wide use by vehicle manufacturers.

This Glossary contains definitions for abbreviations and terms you may find in this manual or in your vehicle service manual. These definitions **may not** agree with those contained in SAE J1930.

GLOSSARY OF TERMS AND ABBREVIATIONS

4EAT – Ford electronic automatic 4 speed transaxle.

A/C – Air Conditioning.

A4LD – Ford automatic 4 speed lock-up converter drive.

AAC – Auxiliary Air Control Valve.

ABS – Anti-Lock Brake System.

ACC – Air Conditioning Clutch compressor signal input to computer relating status of air conditioning clutch.

ACCS – Air Conditioning Cycling Switch.

ACD – Air Conditioner Demand switch.

ACT – Air Charge Temperature sensor or signal circuit.

ACV – (Thermactor) Air Control Valve.

AIR – Secondary air injection (formerly thermactor).

AIR BPV – Thermactor Air Bypass Valve.

AM1 – Thermactor Air Management (TAB).

AM2 – Thermactor Air Management (TAD).

AMBIENT TEMPERATURE – Temperature of air surrounding vehicle being serviced.

ANTI-BFV – Anti-Backfire Valve.

AOD – Automatic Over Drive transmission.

ATDC – After Top Dead Center.

AVOM – Analog Volt/Ohm Meter.

AXOD – Automatic Overdrive transaxle.

AXOD-E – Automatic Overdrive transaxle, electronically controlled.

BAC – Bypass Air Control valve.

BARO – Barometric Pressure.

BASE IDLE – Idle RPM when the throttle lever rests on the throttle stop and the Idle Speed Control is fully retracted and disconnected.

BCM – Body Computer Module.

BOO – Brake On-Off input to the computer.

BOOST – Condition of over-pressure (above atmospheric) in the intake manifold; caused by intake air being forced in by a turbocharger or supercharger.

BP – Barometric Pressure sensor. Used to compensate for altitude variations.

BPA – ByPass Air solenoid.

BTDC – Before Top Dead Center.

BVT – Back-pressure Variable Transducer.

CANISTER – A container, in an evaporative emission system, that contains charcoal to trap fuel vapors from the fuel system.

CANISTER PURGE SOLENOID – Electrical solenoid or its control line. Solenoid opens a valve from fuel vapor canister line to intake manifold when energized. Controls flow of vapors between carburetor bowl vent and carbon canister.

CANP – Canister Purge solenoid.

CATALYTIC CONVERTER – Muffler like assembly placed in exhaust system that contains a catalyst to change hydrocarbons and carbon monoxide into water vapor and carbon dioxide.

CCC – Converter Clutch Control solenoid or its circuit.

CCD – Computer Controlled Dwell, used on Ford Vehicles.

CCO – Converter Clutch Override output from the computer processor to the transmission.

CCS – Coast Clutch Solenoid or its circuit.

CENTRAL FUEL INJECTION – Computer control fuel injection at throttle body, used on Fords, same as throttle body injection.

CER – Cold Enrichment Rod.

CES – Clutch Engage Switch.

CFI – Central Fuel Injection.

CHECK ENGINE LIGHT – Dash panel light used either to aid in identification and diagnosis of a system problems or to indicate that maintenance is required.

CHECK VALVE – Valve that operates like a one-way gate.

CID – Cylinder Identification sensor or its circuit.

CKT – Circuit.

CL – Closed Loop.

CLC – Converter Lock-up Clutch.

CO – Carbon Monoxide.

COC – Conventional Oxidation Catalyst.

COMPUTER TIMING – Total spark advance in degrees before top dead center. Calculated by Ford EEC-IV processor, based on sensor input.

CONTINUOUS SELF-TEST – Continuous test of Ford EEC-IV system conducted whenever vehicle is in operation.

CPS – Crankshaft Position Sensor. Provides the ECU with engine speed and crankshaft angle (position).

CTS – Coolant Temperature Sensor.

CURB IDLE – Computer controlled idle rpm.

CVR – Control Vacuum Regulator.

CWM – Cold Weather Modulator.

CYLINDER IDENTIFICATION SIGNAL (CID) – A signal generated by crankshaft timing sensor, used to synchronize ignition coils, due to the fact that some models use a 2 ignition coil pack DIS system.

C³I – Computer Controlled Coil Ignition. Produces ignition spark without aid of an ignition distributor.

DCL – Data Communications Link.

DERM – Diagnostic Energy Reserve Module and air bag (SIR) controller.

DFS – Decel Fuel Shut-off.

DIC – Driver Information Center.

DID – Driver Information Display.

DIS – Direct Ignition System. Produces ignition spark without aid of an ignition distributor. (Similar to C3I).

DOL – Data Output Link. Fuel calculation data from EEC-IV processor to trip computer.

DPDIS – Dual Plug Distributorless Ignition System, used on some Ford 2.3L engines.

DPI – Dual Plug Inhibit, used on some Ford 2.3L engines.

DUAL CATALYTIC CONVERTER – Combines 2 converters in one shell. Controls NO_x, HC and CO. Also called TWC.

DURA SPARK SYSTEM – The Ford ignition system used with the 5.8L feedback carbureted MCU control system.

DV TW – Delay Valve, 2 Way.

DVM (10 MEG) – Digital voltmeter with a minimum of 10 million ohms resistance. Allows measurement in circuit without affecting the circuit operation.

DWELL – Amount of time (recorded on a dwell meter in degrees) that current passes through a closed switch.

E4OD – Ford Electronic 4 speed Overdrive transmission.

EAS – Electronic Air Switching, directs airflow to catalytic converter or exhaust ports of the engine.

EBCM – Electronic Brake Control Module.

ECA – Electronic Control Assembly. Ford's engine controlling computer.

ECM – Engine Control Module properly call a Powertrain Control Module.

ECT – Engine Coolant Temperature sensor or circuit.

ECU – Electronic Control Unit. To process input information to trigger ignition control module.

EDF – Electro-Drive Fan relay or its circuit.

EEC-IV – Electronic Engine Control design 4. A computer controlled system of engine control used on Ford.

EECS – Evaporative Emission Control System.

EEGR – Electronic Exhaust Gas Recirculation valve (Sonic).

EEPROM – Electronically Erasable Programmable Read Only Memory.

EET – Electronic Exhaust Gas Recirculation Transducer.

EFC – Electronic Feedback Carburetor. Utilizes an electronic signal, generated by an exhaust gas oxygen sensor to precisely control air/fuel mixture ratio in the carburetor.

EFI – Electronic Fuel Injection. Computer controlled fuel injection system. On Ford EFI uses injectors in each intake port and CFI uses an injector in the throttle body.

EGO – Exhaust Gas Oxygen sensor.

EGR – Exhaust Gas Recirculation system is designed to allow flow of inert exhaust gases into combustion chamber to cool combustion and reduce nitrous oxides in exhaust.

EHC – Exhaust Heat Control vacuum solenoid or its circuit.

EIC – Electronic Instrument Cluster.

ELECTRONIC SPARK CONTROL – Used to retard spark advance if detonation occurs.

ELECTRONIC SPARK TIMING – PCM controlled timing of the ignition spark.

EMR – Electronic Module Retard, controls spark retard.

ENGINE CONTROL MODULE – A microprocessor based device which contains electronic circuitry to control and monitor air/fuel and emission systems, and aid in diagnostics.

EPC – Electronic Pressure Control solenoid.

EPROM – Erasable Programmable Read Only Memory.

ER – Engine running, used on some Ford system tests.

ERS – Engine RPM Sensor.

ESA – Electronic Spark Advance.

ESC – Electronic Spark Control.

EST – Electronic Spark Timing.

EVP – EGR Valve Position sensor or its circuit.

EVR – EGR Vacuum Regulator or its circuit.

EVRV – Electronic Vacuum Regulator Valve. Controls EGR vacuum.

EXHAUST GAS OXYGEN SENSOR – Sensor that changes its voltage output as exhaust gas oxygen content changes as compared to oxygen content of the atmosphere. The constantly changing electrical signal is used to control fuel mixture.

EXHAUST GAS RECIRCULATION – Procedure where a small amount of exhaust gas is readmitted to combustion chamber to reduce peak combustion temperatures, thus reducing NO_x.

FAIL SAFE – or Fail Soft: any attempt by a computer to compensate for a fault or lost signal, usually by substituting fixed replacement valves.

FEEDBACK CARBURETOR (FBC) – System of fuel control employing a computer controlled solenoid that varies the carburetors air/fuel mixture.

FEEDBACK CARBURETOR ACTUATOR – Computer controlled stepper motor used on Ford feedback carburetors, that varies air/fuel mixture.

FMEM – Failure Mode Effects Management. Sometimes referred to limp-in mode.

FTO – Filter Tach Output. An output from Ford DIS TFI IV module which provides a filtered ignition signal to the processor in order to control dwell.

GND, GRD or GRND – Ground. Common line leading to the negative side of the battery.

HALL EFFECT – Process where current is passed through a small slice of semiconductor material at the same time as a magnetic field to produce a small voltage in the semiconductor.

HARD FAULT – Fault present during current engine operating cycle. Opposite of an intermittent fault which does not stay present.

HBV – Heater Blower Voltage input to EEC-IV processor reflecting heater blower voltage demand.

HEDF – High-speed Electro-Drive Fan relay or its circuit.

HEGO – Heated Oxygen Sensor or its circuit.

HIC – Hot Idle Compensator.

H.O. – Height Output

HSC – High Swirl Combustion

IAC – Idle Air Control.

IAS – Inlet Air Solenoid valve or its circuit.

IAT – Intake air temperature sensor, performs same function as MAT sensor.

ICM – Integrated Control Module.

IDLE TRACKING SWITCH – An input device that sends a signal to the computer to indicate a closed throttle condition.

IDM – Ignition Diagnostics Monitor. Continuous monitor of ignition input to EEC-IV processor used to detect intermittent ignition faults.

IGN – Ignition.

INTERMITTENT FAULT – Fault which occurred during a previous engine operating cycle. Intermittent fault may have set a fault code which is still present in PCM memory.

IRCM – Integrated Relay Control Module, used on some Ford systems.

ISA – Idle Speed Actuator. Extends or retracts to control engine idle speed and to set throttle stop angle during deceleration.

ISC – Idle Speed Control, either computer control motor, air bypass valve, or any device used to control idle rpm.

ITS – Idle Tracking Switch.

KAM – Keep Alive Memory. Battery power memory locations in computer used to store failure codes and some diagnostic parameters.

- KAPWR** – Keep Alive Power, used to power KAM circuit of the processor.
- KNOCK SENSOR (KS)** – Input device that responds to spark knock, caused by over advanced ignition timing.
- KOEO** – Key On/Engine Off.
- KOER** – Key On/Engine Running.
- LEAN MIXTURE** – Air/fuel mixture that has excessive oxygen left after all fuel in combustion chamber has burned, 1 part fuel to 15 or more parts air.
- LED** – Light Emitting Diode.
- LOCK UP TORQUE CONVERTER** – Converter with internal mechanism that locks turbine to impeller when engaged.
- LUS** – Lock-Up Solenoid.
- M/C** – Mixture control or mixture control solenoid.
- MAF** – Mass Air Flow sensor, used to measure amount of airflow through the throttle body.
- MAP** – Manifold Absolute Pressure sensor or its circuit.
- MAT** – Manifold Air Temperature.
- MFI** – Multi-port Fuel Injection.
- MIL** – Malfunction Indicator Light. Check engine light.
- MICROPROCESSOR CONTROL UNIT (MCU)** – The controlling computer, used on early Ford feedback carburetor systems and all 5.8L feedback carburetor equipped Fords.
- MIXTURE CONTROL SOLENOID** – Device installed on carburetor, that regulates the air/fuel ratio.
- MLP** – Manual (shift) Lever Position sensor or its circuit.
- MPFI** – Multi-Port Fuel Injection.
- MULTI-PORT FUEL INJECTION** – Individual injectors for each cylinder mounted in intake manifold. Injectors are pulsed in groups rather than individually.
- NDS** – Neutral Drive Switch.
- NGS** – Neutral Gear Switch or its circuit.
- NON-VOLATILE MEMORY** – Memory retained in block learn cells (not affected by turning the ignition ON or OFF).
- NO_x** – Nitrous Oxides.
- NPS** – Neutral Pressure Switch or its circuit.
- OCT ADJ** – Octane Adjust device which modifies ignition spark.

OHC – Overhead Cam

OXYGEN SENSOR – Sensor that changes its voltage output as exhaust gas oxygen content changes as compared to the oxygen content of the atmosphere. The constantly changing electrical signal is used to control fuel mixture.

PCM – Powertrain Control Module. Computer that controls engine fuel, ignition and emission related functions.

PCV – Positive Crankcase Ventilation. System that controls flow of crankshaft vapors into engine intake manifold where they are burned in combustion rather than being discharged into the atmosphere.

PFE – Pressure Feedback EGR sensor or its circuit.

PFI – Port Fuel Injection.

PIP – Profile Ignition Pickup.

PORTED VACUUM SWITCH – Temperature actuated switch that changes vacuum connections when the coolant temperature changes.

POT – Potentiometer.

POWERTRAIN CONTROL MODULE – Same as ECM, but also controls electronically controlled automatic transmission.

PROFILE IGNITION PICKUP – A Hall effect vane switch that furnishes crankshaft position data to the EEC-IV processor.

PROM – Programmable Read Only Memory.

PSPS – Power Steering Pressure Switch. Signal is used by computer to compensate for power steering loads.

PVS – Ported Vacuum Switch.

QUICK TEST – A functional diagnostic test for Ford EEC-IV system, consisting of test hookup, key on engine off, engine running and continuous self test models.

RAP – Retained Accessory Power.

RELAY – Switching device operated by a low current circuit, which controls opening and closing of another higher current circuit.

RELIEF VALVE – Pressure limiting valve located in exhaust chamber of thermactor air pump. Relieves part of exhaust airflow if pressure exceeds a calibrated value.

RICH MIXTURE – Air/fuel mixture that has more fuel than can burn completely, 1 part fuel to 14 or less parts air.

SAW – Spark Advance Word, and also Spark Angle Word.

SC – Super Charged

SCC – Spark Control Computer.

SEFI – Sequential Electronic Fuel Injection. Injectors located in intake ports that inject fuel triggered by ignition timing.

SELF-TEST – One of 3 subsets of Ford EEC-IV quick test modes.

SES – Service Engine Soon light.

SFI – Sequential Fuel Injection, type of MFI with injectors pulsed individually based on engine firing order.

SHO – Super Height Output

SIG RTN – Signal Return circuit for all sensors except HEGO.

SIL – Shift Indicator Light. Indicates to driver optimum time to shift gears.

SIR – Supplemental Inflatable Restraint (SIR) system; air bag.

SIS – Solenoid Idle Stop.

SOLENOID – Wire coil with a movable core which changes position by means of electromagnetism when current flows through the coil.

SPARK RETARD SOLENOID – Output device that receives an output signal from Ford MCU system to bleed distributor's vacuum advance when spark knock occurs.

SPOUT – Spark output signal from EEC-IV processor to TFI-IV module, used to control amount of timing retard.

SSI – Solid State Ignition system.

STI – Self Test Input (Ford) circuit in EEC or MCU systems. Used to place computer into testing mode.

STO – Self Test Output (Ford) circuit in EEC or MCU systems. Used by computer to send testing and fault codes to tester.

T.V. – Throttle Valve.

TAB – Thermactor Air Bypass solenoid.

TACH INPUT – Engine rpm signal sent to computer from ignition coil primary circuit.

TAD – Thermactor Air Diverter solenoid.

TBI – Throttle Body Injection (Fuel).

TCC – Torque Converter Clutch.

TCP – Temperature Compensating Pump.

TDC – Top Dead Center.

TFI – Thick Film Ignition module. Controls coil and ignition operation on most Ford vehicles.

THERMACTOR AIR BYPASS SOLENOID – Solenoid switches engine manifold vacuum. Vacuum reacts on thermactor bypass valve to bypass thermactor air to the atmosphere. Used on Ford MCU feedback carburetor system.

THERMACTOR AIR CONTROL VALVE – Combines function of a normally closed air bypass valve and an air diverter valve in one integral valve.

THERMACTOR AIR DIVERTER SOLENOID – Solenoid switches engine manifold vacuum. Vacuum switches thermactor air from downstream (past EGO sensor) to upstream (before EGO sensor) when solenoid is energized. Used on Ford MCU feedback carburetor system.

THERMACTOR AIR SYSTEM – Efficiency of catalytic converter is dependent upon temperature and chemical makeup of exhaust gases. These requirements are met by the thermactor air supply system.

THREE-WAY CATALYST – Combines 2 converters in 1 shell. Controls NO_x, HC and CO. Also called dual catalytic converter.

TIMING – Relationship between spark plug firing and piston position.

TK – Throttle Kicker solenoid, when energized, supplies manifold vacuum to throttle kicker actuator as directed by computer to compensate for engine loads. Also called idle-up system.

TOT – Transmission Oil Temperature sensor.

TP – Throttle Position sensor or its circuit. Used to signal computer the position of the throttle plates.

TPI – Tuned Port Injection, a type of MFI with intake tubes designed to be tuned for performance. Most TPI engines are also SFI.

TTS – Transmission Temperature Switch.

TVS – Temperature Vacuum Switch.

TVV – Thermal Vent Valve.

TWC – Three-Way Catalyst.

VACUUM – A term to describe a pressure that is less than atmospheric pressure.

VACUUM ADVANCE – Advances ignition timing with relation to engine load or computer signals.

VAF – Vane Air-Flow sensor or its circuit.

VAT – Vane Air-Flow Temperature sensor.

VM – Vane Meter or air flow meter.

VSS – Vehicle Speed Sensor.

WOT – Wide Open Throttle or Wide Open Throttle switch.

ZONED VACUUM SWITCHES – 3 switches used on Ford MCU system that provides input signals to MCU, regarding engine load.

LIMITED ONE YEAR WARRANTY

The Manufacturer warrants to the original purchaser that this unit is free of defects in materials and workmanship for a period of one (1) year from the date of original purchase. If the unit fails within the one (1) year period, it will be repaired or replaced, at the Manufacturer's option, at no charge, when returned prepaid to the Technical Service Center with Proof of Purchase. The sales receipt may be used for this purpose. Installation labor is not covered under this warranty.

All replacement parts, whether new or re-manufactured, assume as their warranty period for only the remaining time of this warranty. This warranty does not apply to damage caused by improper use, accident, abuse, or if the product was altered or repaired by anyone other than the Manufacturer's Technical Service Center. Consequential and incidental damages are not recoverable under this warranty. Some states do not allow the exclusion or limitation of incidental or consequential damages, so the above limitation or exclusion may not apply to you.

This warranty gives you specific legal rights, and you may also have other rights, which vary from state to state. No portion of this warranty may be copied or duplicated without the expressed written permission from the Manufacturer.

TECHNICAL ASSISTANCE AND WARRANTY SERVICE

Products requiring service should be returned as follows:

1. Call the Technical Service Center to obtain a Return Reference Number:
2. Package the product carefully to prevent shipping damage
3. Include your name, return address, and a day contact phone
4. Enclose a copy of the dated sales receipt
5. Describe the problem
6. Ship prepaid to: Technical Service Center, 17352 Von Karman Ave., Irvine, CA 92614, U.S.A.

For Technical Assistance/Warranty Service, contact us at:

Phone: USA & Canada 1-800-544-4124, Others
714-241-6805; Fax: 714-432-7910; Web: www.equus.com;
Email: service@equus.com







SERVICE IN USA

WE EMPLOY TECHNICIANS CERTIFIED BY ASE ONLY.
LET US SHOW YOU THEIR CREDENTIALS.

www.equus.com

INNOVA[®]

Innova Electronics Corp.
17532 Von Karman Ave.
Irvine, CA 92614
Printed in Taiwan

Instruction MRP #93-0029 Rev. A



Copyright © 2011 IEC. All Rights Reserved.

