

CarScan[®]



YOU CAN DO IT!	1
SAFETY PRECAUTIONS	
SAFETY FIRST!	2
ABOUT THE SCAN TOOL	
VEHICLES COVERED	3
CONTROLS AND INDICATORS	4
DISPLAY FUNCTIONS	5
DISPLAY AND SETTINGS	6
ONBOARD DIAGNOSTICS	
COMPUTER ENGINE CONTROLS	8
DIAGNOSTIC TROUBLE CODES (DTCs)	13
OBD2 MONITORS	16
PREPARATION FOR TESTING	
BEFORE YOU BEGIN	25
VEHICLE SERVICE MANUALS	25
USING THE SCAN TOOL	
CODE RETRIEVAL PROCEDURE	26
ERASING DIAGNOSTIC TROUBLE CODES (DTCs)	31
ABOUT REPAIRSOLUTIONS®	33
ADDITIONAL FUNCTIONS	
THE MAIN MENU	38
EVAP TEST	38
VIEWING MONITOR ICON DESCRIPTIONS	39
VIEWING THE LED MEANING	40
ADJUSTMENTS AND SETTINGS	40
WARRANTY AND SERVICING	
LIMITED ONE YEAR WARRANTY	45
SERVICE PROCEDURES	45

Easy To Use

- Connect the Scan Tool to the vehicle's test connector.
- Turn the ignition key "On." DO NOT start the engine.
- The Scan Tool will automatically link to the vehicle's computer.

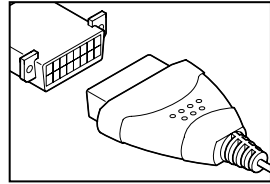

Easy To View

- The Scan Tool retrieves stored codes, Freeze Frame data I/M Readiness status.
- Codes, I/M Readiness status and Freeze Frame data are displayed on the Scan Tool's display screen. System status is indicated by LED indicators.

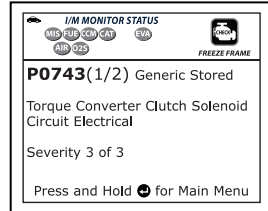

Easy To Define

- Read code definitions from the Scan Tool's display
- View Freeze Frame data.

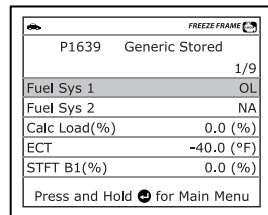

SAFETY FIRST!

This manual describes common test procedures used by experienced service technicians. Many test procedures require precautions to avoid accidents that can result in personal injury, and/or damage to your vehicle or test equipment. Always read your vehicle's service manual and follow its safety precautions before and during any test or service procedure. **ALWAYS** observe the following general safety precautions:



When an engine is running, it produces carbon monoxide, a toxic and poisonous gas. To prevent serious injury or death from carbon monoxide poisoning, operate the vehicle **ONLY** in a **well-ventilated** area.



To protect your eyes from propelled objects as well as hot or caustic liquids, **always** wear **approved** safety eye protection.



When an engine is running, many parts (such as the coolant fan, pulleys, fan belt etc.) turn at high speed. To avoid serious injury, always be aware of moving parts. Keep a safe distance from these parts as well as other potentially moving objects.



Engine parts become very hot when the engine is running. To prevent severe burns, avoid contact with hot engine parts.



Before starting an engine for testing or trouble-shooting, make sure the parking brake is engaged. Put the transmission in **park** (for automatic transmission) or **neutral** (for manual transmission). Block the drive wheels with suitable blocks.



Connecting or disconnecting test equipment when the ignition is **ON** can damage test equipment and the vehicle's electronic components. Turn the ignition **OFF** before connecting the Code Reader to or disconnecting the Code Reader from the vehicle's Data Link Connector (DLC).



To prevent damage to the on-board computer when taking vehicle electrical measurements, always use a digital multimeter with at least 10 MegOhms of impedance.



The vehicle's battery produces highly flammable hydrogen gas. To prevent an explosion, keep all sparks, heated items and open flames away from the battery.



Don't wear loose clothing or jewelry when working on an engine. Loose clothing can become caught in the fan, pulleys, belts, etc. Jewelry is highly conductive, and can cause a severe burn if it makes contact between a power source and ground.

VEHICLES COVERED

The Scan Tool is designed to work on all OBD2 compliant vehicles. All 1996 and newer vehicles (cars and light trucks) sold in the United States are OBD2 compliant. This includes all Domestic, Asian and European vehicles.

Some 1994 and 1995 vehicles are OBD2 compliant. To find out if a 1994 or 1995 vehicle is OBD2 compliant, check the following:

1. **The Vehicle Emissions Control Information (VECI) Label.** This label is located under the hood or by the radiator of most vehicles. If the vehicle is OBD2 compliant, the label will state “**OBD II Certified.**”

VEHICLE EMISSION CONTROL INFORMATION			
VEHICLE MANUFACTURER	ENGINE FAMILY	EFN2.6YBT2BA	OBD II CERTIFIED
	DISPLACEMENT	2.6L	
THIS VEHICLE CONFORMS TO U.S. EPA AND STATE OF CALIFORNIA REGULATIONS APPLICABLE TO 1999 MODEL YEAR NEW TLEV PASSENGER CARS.			
REFER TO SERVICE MANUAL FOR ADDITIONAL INFORMATION TUNE-UP CONDITIONS: NORMAL OPERATING ENGINE TEMPERATURE, ACCESSORIES OFF, COOLING FAN OFF, TRANSMISSION IN NEUTRAL			
EXHAUST EMISSIONS STANDARDS		STANDARD CATEGORY	
CERTIFICATION IN-USE		TLEV TLEV INTERMEDIATE	
SPARK PLUG TYPE NGK BPRE-11 GAP: 1.1MM	CATALYST	[Barcode]	

OBD II
CERTIFIED

2. Government Regulations require that all OBD2 compliant vehicles must have a “common” sixteen-pin **Data Link Connector (DLC)**.

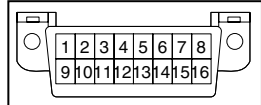

Some 1994 and 1995 vehicles have 16-pin connectors but are not OBD2 compliant. Only those vehicles with a Vehicle Emissions Control Label stating “OBD II Certified” are OBD2 compliant.

Data Link Connector (DLC) Location

The 16-pin DLC is usually located under the instrument panel (dash), within 12 inches (300 mm) of center of the panel, on the driver’s side of most vehicles. It should be easily accessible and visible from a kneeling position outside the vehicle with the door open.

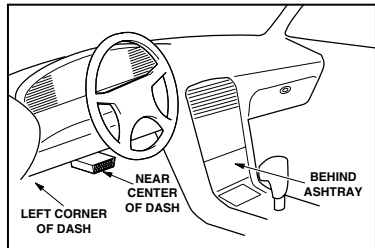

On some Asian and European vehicles the DLC is located behind the “ashtray” (the ashtray must be removed to access it) or on the far left corner of the dash. If the DLC cannot be located, consult the vehicle’s service manual for the location.

CONTROLS AND INDICATORS

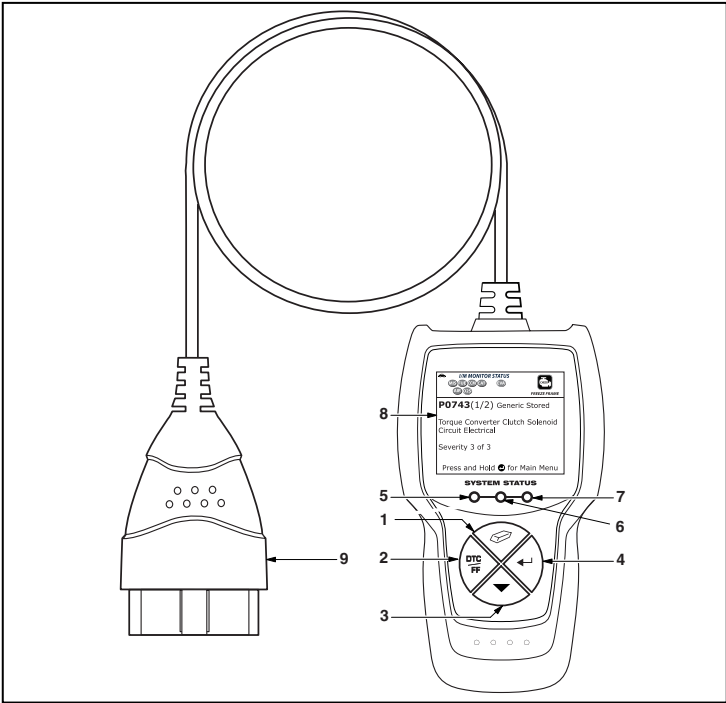

Figure 1. Controls and Indicators

See Figure 1 for the locations of items 1 through 9, below.

1. **ERASE button** - Erases Diagnostic Trouble Codes (DTCs) and "Freeze Frame" data from your vehicle's computer, and resets Monitor status.
2. **DTC/FF button** - Displays the DTC View screen and/or scrolls the LCD display to view DTCs and Freeze Frame data.
3. **DOWN button** - When in MENU mode, scrolls down through the menu and submenu selection options. When LINKED to a vehicle, scrolls down through the current display screen to display any additional data.
4. **ENTER button** - When in MENU mode, confirms the selected option or value.
5. **GREEN LED** - Indicates that all engine systems are running normally (all Monitors on the vehicle are active and performing their diagnostic testing, and no DTCs are present).

- YELLOW LED** - Indicates there is a possible problem. A "Pending" DTC is present and/or some of the vehicle's emission monitors have not run their diagnostic testing.
- RED LED** - Indicates there is a problem in one or more of the vehicle's systems. The red LED is also used to show that DTC(s) are present. DTCs are shown on the Scan Tool's LCD display. In this case, the Multifunction Indicator ("Check Engine") lamp on the vehicle's instrument panel will light steady on.
- LCD Display** - Displays test results, Scan Tool functions and Monitor status information. See DISPLAY FUNCTIONS, below, for details.
- CABLE** - Connects the Scan Tool to the vehicle's Data Link Connector (DLC).

DISPLAY FUNCTIONS

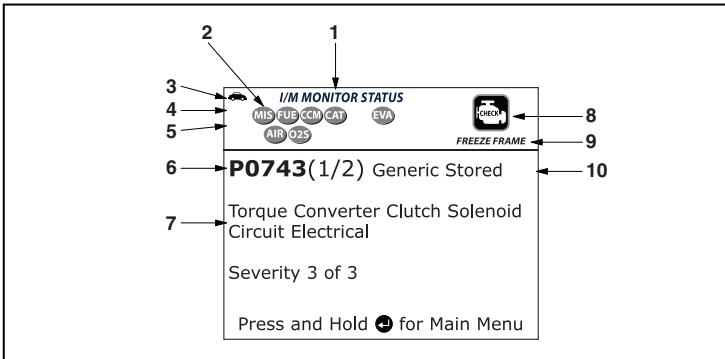





Figure 2. Display Functions

See Figure 2 for the locations of items 1 through 10, below.

- I/M MONITOR STATUS field** - Identifies the I/M Monitor status area.
- Monitor icons** - Indicate which Monitors are supported by the vehicle under test, and whether or not the associated Monitor has run its diagnostic testing (Monitor status). When a Monitor icon is solid, it indicates that the associated Monitor has completed its diagnostic testing. When a Monitor icon is flashing, it indicates that the vehicle supports the associated Monitor, but the Monitor has not yet run its diagnostic testing.
- Vehicle icon** - Indicates whether or not the Scan Tool is being properly powered through the vehicle's Data Link Connector (DLC). A visible icon indicates that the Scan Tool is being powered through the vehicle's DLC connector.

-  **Link icon** - Indicates whether or not the Scan Tool is communicating (linked) with the vehicle's on-board computer. When visible, the Scan Tool is communicating with the computer. If the Link icon is not visible, the Scan Tool is not communicating with the computer.
-  **Computer icon** - When this icon is visible it indicates that the Scan Tool is linked to a personal computer. Optional software is available that makes it possible to upload retrieved data to a personal computer.
- DTC Display Area** - Displays the Diagnostic Trouble Code (DTC) number. The DTC number is color-coded as follows: Each fault is assigned a code number that is specific to that fault.
 - **RED** – Indicates the currently displayed DTC is a PERMANENT DTC.
 - **YELLOW** – Indicates the currently displayed DTC is a PENDING DTC.
 - **GREEN** – In cases where no codes are retrieved, a “No DTCs are presently stored in the vehicle’s computer” message is shown in green.
- Test Data Display Area** - Displays DTC definitions, Freeze Frame data and other pertinent test information messages.
- SYSTEM icon** - Indicates the system with which the code is associated:
 MIL icon
- FREEZE FRAME icon** - Indicates that there is Freeze Frame data from “Priority Code” (Code #1) stored in the vehicle’s computer memory.
- Code type** - Indicates the type of code being displayed; Generic Stored, Generic Pending, Generic permanent, etc.







The I/M Monitor Status icons are associated with INSPECTION and MAINTENANCE (I/M) READINESS STATUS. Some states require that all vehicle Monitors have run and completed their diagnostic testing before a vehicle can be tested for Emissions (Smog Check). A maximum of fifteen Monitors are used on OBD2 systems. Not all vehicles support all fifteen Monitors. When the Scan Tool is linked to a vehicle, only the icons for Monitors that are supported by the vehicle under test are visible on the display.

DISPLAY AND SETTINGS

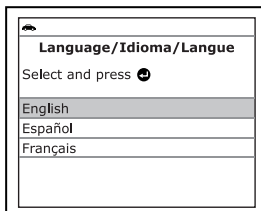
The first time the unit is connected to a vehicle, you must select the desired display language (English, French or Spanish) and unit of measurement (USA or Metric) as follows:

- Use the **DOWN** ▼ button to highlight the desired display language.



2. When the desired display language is selected, press the **ENTER**  button to confirm your selection.
 - The Unit of Measurement screen displays.
3. Use the **DOWN**  button to highlight the desired unit of measurement.
4. When the desired unit of measurement is selected, press the **ENTER**  button to confirm your selection.
 - The Firmware Screen displays for three seconds.

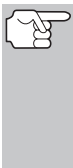
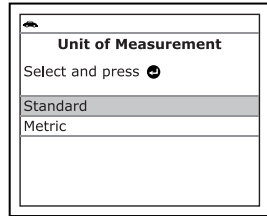

*After the initial language and unit of measurement selections are performed, these, as well as other settings, can be changed as desired. Proceed to **ADJUSTMENTS AND SETTINGS** on page 40 for further instructions.*

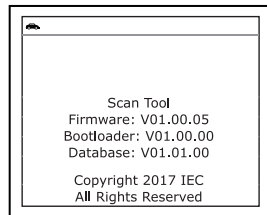

COMPUTER ENGINE CONTROLS

The Introduction of Electronic Engine Controls

Electronic Computer Control Systems make it possible for vehicle manufacturers to comply with the tougher emissions and fuel efficiency standards mandated by State and Federal Governments.

As a result of increased air pollution (smog) in large cities, such as Los Angeles, the California Air Resources Board (**CARB**) and the Environmental Protection Agency (**EPA**) set new regulations and air pollution standards to deal with the problem. To further complicate matters, the energy crisis of the early 1970s caused a sharp increase in fuel prices over a short period. As a result, vehicle manufacturers were not only required to comply with the new emissions standards, they also had to make their vehicles more fuel-efficient. Most vehicles were required to meet a miles-per-gallon (MPG) standard set by the U.S. Federal Government.



Precise fuel delivery and spark timing are needed to reduce vehicle emissions. Mechanical engine controls in use at the time (such as ignition points, mechanical spark advance and the carburetor) responded too slowly to driving conditions to properly control fuel delivery and spark timing. This made it difficult for vehicle manufacturers to meet the new standards.

A new Engine Control System had to be designed and integrated with the engine controls to meet the stricter standards. The new system had to:

- Respond instantly to supply the proper mixture of air and fuel for any driving condition (idle, cruising, low-speed driving, high-speed driving, etc.).
- Calculate instantly the best time to “ignite” the air/fuel mixture for maximum engine efficiency.
- Perform both these tasks without affecting vehicle performance or fuel economy.

Vehicle Computer Control Systems can perform millions of calculations each second. This makes them an ideal substitute for the slower mechanical engine controls. By switching from mechanical to electronic engine controls, vehicle manufacturers are able to control fuel delivery and spark timing more precisely. Some newer Computer Control Systems also provide control over other vehicle functions, such as transmission, brakes, charging, body, and suspension systems.

The Basic Engine Computer Control System

The Computer Control System consists of an on-board computer and several related control devices (sensors, switches, and actuators).

The on-board computer is the heart of the Computer Control System. The computer contains several programs with preset reference values for air/fuel ratio, spark or ignition timing, injector pulse width, engine speed, etc. Separate values are provided for various driving conditions, such as idle, low speed driving, high-speed driving, low load, or high load. The preset reference values represent the ideal air/fuel mixture, spark timing, transmission gear selection, etc., for any driving condition. These values are programmed by the vehicle manufacturer, and are specific to each vehicle model.



Most on-board computers are located inside the vehicle behind the dashboard, under the passenger's or driver's seat, or behind the right kick panel. However, some manufacturers may still position it in the engine compartment.

Vehicle sensors, switches, and actuators are located throughout the engine, and are connected by electrical wiring to the on-board computer. These devices include oxygen sensors, coolant temperature sensors, throttle position sensors, fuel injectors, etc. Sensors and switches are **input devices**. They provide signals representing current engine operating conditions to the computer. Actuators are **output devices**. They perform actions in response to commands received from the computer.

The on-board computer receives information inputs from sensors and switches located throughout the engine. These devices monitor critical engine conditions such as coolant temperature, engine speed, engine load, throttle position, air/fuel ratio etc.

The computer compares the values received from these sensors with its preset reference values, and makes corrective actions as needed so that the sensor values always match the preset reference values for the current driving condition. The computer makes adjustments by commanding other devices such as the fuel injectors, idle air control, EGR valve or Ignition Module to perform these actions.

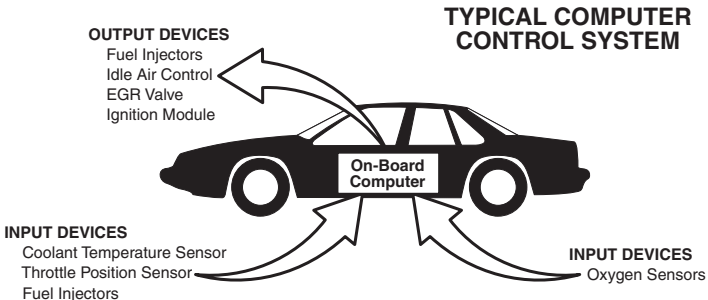

Vehicle operating conditions are constantly changing. The computer continuously makes adjustments or corrections (especially to the air/fuel mixture and spark timing) to keep all the engine systems operating within the preset reference values.

On-Board Diagnostics - First Generation (OBD1)

With the exception of some 1994 and 1995 vehicles, most vehicles from 1982 to 1995 are equipped with some type of first generation On-Board Diagnostics.



Beginning in 1988, California's Air Resources Board (**CARB**), and later the Environmental Protection Agency (**EPA**) required vehicle manufacturers to include a self-diagnostic program in their on-board computers. The program would be capable of identifying emissions-related faults in a system. The first generation of Onboard Diagnostics came to be known as **OBD1**.

OBD1 is a set of self-testing and diagnostic instructions programmed into the vehicle's on-board computer. The programs are specifically designed to detect failures in the sensors, actuators, switches and wiring of the various vehicle emissions-related systems. If the computer detects a failure in any of these components or systems, it lights an indicator on the dashboard to alert the driver. The indicator lights **only** when an emissions-related problem is detected.

The computer also assigns a numeric code for each specific problem that it detects, and stores these codes in its memory for later retrieval. These codes can be retrieved from the computer's memory with the use of a "Code Reader" or a "Scan Tool."

On-Board Diagnostics - Second Generation (OBD2)

In addition to performing all the functions of the OBD1 System, the OBD2 System has been enhanced with new Diagnostic Programs. These programs closely monitor the functions of various emissions-related components and systems (as well as other systems) and make this information readily available (with the proper equipment) to the technician for evaluation.

The OBD2 System is an enhancement of the OBD1 System.

The California Air Resources Board (**CARB**) conducted studies on OBD1 equipped vehicles. The information that was gathered from these studies showed the following:

- A large number of vehicles had deteriorating or degraded emissions-related components. These components were causing an increase in emissions.



- Because OBD1 systems only detect failed components, the degraded components were not setting codes.
- Some emissions problems related to degraded components only occur when the vehicle is being driven under a load. The emission checks being conducted at the time were not performed under simulated driving conditions. As a result, a significant number of vehicles with degraded components were passing Emissions Tests.
- Codes, code definitions, diagnostic connectors, communication protocols and emissions terminology were different for each manufacturer. This caused confusion for the technicians working on different make and model vehicles.

To address the problems made evident by this study, CARB and the EPA passed new laws and standardization requirements. These laws required that vehicle manufacturers to equip their new vehicles with devices capable of meeting all of the new emissions standards and regulations. It was also decided that an enhanced on-board diagnostic system, capable of addressing all of these problems, was needed. This new system is known as **“On-Board Diagnostics Generation Two (OBD2).”** The primary objective of the OBD2 system is to comply with the latest regulations and emissions standards established by CARB and the EPA.

The Main Objectives of the OBD2 System are:

- To detect degraded and/or failed emissions-related components or systems that could cause tailpipe emissions to exceed by 1.5 times the Federal Test Procedure (FTP) standard.
- To expand emissions-related system monitoring. This includes a set of computer run diagnostics called Monitors. Monitors perform diagnostics and testing to verify that all emissions-related components and/or systems are operating correctly and within the manufacturer’s specifications.
- To use a standardized Diagnostic Link Connector (DLC) in all vehicles. (Before OBD2, DLCs were of different shapes and sizes.)
- To standardize the code numbers, code definitions and language used to describe faults. (Before OBD2, each vehicle manufacturer used their own code numbers, code definitions and language to describe the same faults.)
- To expand the operation of the Malfunction Indicator Lamp (MIL).
- To standardize communication procedures and protocols between the diagnostic equipment (Scan Tools, Code Readers, etc.) and the vehicle’s on-board computer.

OBD2 Terminology

The following terms and their definitions are related to OBD2 systems. Read and reference this list as needed to aid in the understanding of OBD2 systems.

- **Powertrain Control Module (PCM)** - The PCM is the OBD2 accepted term for the vehicle's "on-board computer." In addition to controlling the engine management and emissions systems, the PCM also participates in controlling the powertrain (transmission) operation. Most PCMs also have the ability to communicate with other computers on the vehicle (ABS, ride control, body, etc.).
- **Monitor** - Monitors are "diagnostic routines" programmed into the PCM. The PCM utilizes these programs to run diagnostic tests, and to monitor operation of the vehicle's emissions-related components or systems to ensure they are operating correctly and within the vehicle's manufacturer specifications. Currently, up to fifteen Monitors are used in OBD2 systems. Additional Monitors will be added as the OBD2 system is further developed.



Not all vehicles support all fifteen Monitors.

- **Enabling Criteria** - Each Monitor is designed to test and monitor the operation of a specific part of the vehicle's emissions system (EGR system, oxygen sensor, catalytic converter, etc.). A specific set of "conditions" or "driving procedures" must be met before the computer can command a Monitor to run tests on its related system. These "conditions" are known as "**Enabling Criteria.**" The requirements and procedures vary for each Monitor. Some Monitors only require the ignition key to be turned "**On**" for them to run and complete their diagnostic testing. Others may require a set of complex procedures, such as, starting the vehicle when cold, bringing it to operating temperature, and driving the vehicle under specific conditions before the Monitor can run and complete its diagnostic testing.
- **Monitor Has/Has Not Run** - The terms "Monitor has run" or "Monitor has not run" are used throughout this manual. "**Monitor has run,**" means the PCM **has** commanded a particular Monitor to perform the required diagnostic testing on a system to ensure the system is operating correctly (within factory specifications). The term "**Monitor has not run**" means the PCM **has not** yet commanded a particular Monitor to perform diagnostic testing on its associated part of the emissions system.
- **Trip** - A Trip for a particular Monitor requires that the vehicle is being driven in such a way that all the required "Enabling Criteria" for the Monitor to run and complete its diagnostic testing are met. The "Trip Drive Cycle" for a particular Monitor begins when the ignition key is turned "**On.**" It is successfully completed when all the "Enabling Criteria" for the Monitor to run and complete its diagnostic testing are met by the time the ignition key is turned "**Off.**" Since each of the fifteen monitors is designed to run diagnostics and testing on a different part of the engine or emissions system, the "Trip Drive Cycle" needed for each individual Monitor to run and complete varies.

- **OBD2 Drive Cycle** - An OBD2 Drive Cycle is an extended set of driving procedures that takes into consideration the various types of driving conditions encountered in real life. These conditions may include starting the vehicle when it is cold, driving the vehicle at a steady speed (cruising), accelerating, etc. An OBD2 Drive Cycle begins when the ignition key is turned "On" (when cold) and ends when the vehicle has been driven in such a way as to have all the "Enabling Criteria" met for all its applicable Monitors. Only those trips that provide the Enabling Criteria for all Monitors applicable to the vehicle to run and complete their individual diagnostic tests qualify as an OBD2 Drive Cycle. OBD2 Drive Cycle requirements vary from one model of vehicle to another. Vehicle manufacturers set these procedures. Consult your vehicle's service manual for OBD2 Drive Cycle procedures.



Do not confuse a "Trip" Drive Cycle with an OBD2 Drive Cycle. A "Trip" Drive Cycle provides the "Enabling Criteria" for one specific Monitor to run and complete its diagnostic testing. An OBD2 Drive Cycle must meet the "Enabling Criteria" for all Monitors on a particular vehicle to run and complete their diagnostic testing.

- **Warm-up Cycle** - Vehicle operation after an engine off period where engine temperature rises at least 40°F (22°C) from its temperature before starting, and reaches at least 160°F (70°C). The PCM uses warm-up cycles as a counter to automatically erase a specific code and related data from its memory. When no faults related to the original problem are detected within a specified number of warm-up cycles, the code is erased automatically.

DIAGNOSTIC TROUBLE CODES (DTCs)

Diagnostic Trouble Codes (DTCs) are meant to guide you to the proper service procedure in the vehicle's service manual. **DO NOT** replace parts based only on DTCs without first consulting the vehicle's service manual for proper testing procedures for that particular system, circuit or component.

Diagnostic Trouble Codes (DTCs) are codes that identify a specific problem area.

DTCs are alphanumeric codes that are used to identify a problem that is present in any of the systems that are monitored by the on-board computer (PCM). Each trouble code has an assigned message that identifies the circuit, component or system area where the problem was found.



OBD2 diagnostic trouble codes are made up of five characters:

- The 1st character is a **letter** (B, C, P or U). It identifies the "main system" where the fault occurred (Body, Chassis, Powertrain, or Network).
- The 2nd character is a **numeric digit** (0 thru 3). It identifies the "type" of code (Generic or Manufacturer-Specific).



Generic DTCs are codes that are used by all vehicle manufacturers. The standards for generic DTCs, as well as their definitions, are set by the Society of Automotive Engineers (SAE).



Manufacturer-Specific DTCs are codes that are controlled by the vehicle manufacturers. The Federal Government does not require vehicle manufacturers to go beyond the standardized generic DTCs in order to comply with the new OBD2 emissions standards. However, manufacturers are free to expand beyond the standardized codes to make their systems easier to diagnose.

- The 3rd character is a letter or a numeric digit (0 thru 9, A thru F). It identifies the specific system or sub-system where the problem is located.
- The 4th and 5th characters are letters or numeric digits (0 thru 9, A thru F). They identify the section of the system that is malfunctioning.

OBD2 DTC EXAMPLE

P0201 - Injector Circuit Malfunction, Cylinder 1

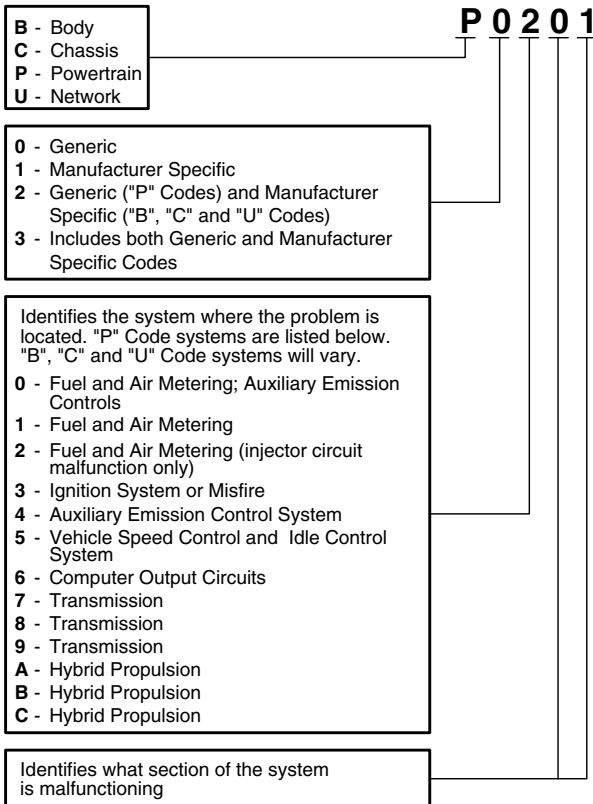

DTCs and MIL Status

When the vehicle's on-board computer detects a failure in an emissions-related component or system, the computer's internal diagnostic program assigns a diagnostic trouble code (DTC) that points to the system (and subsystem) where the fault was found. The diagnostic program saves the code in the computer's memory. It records a "Freeze Frame" of conditions present when the fault was found, and lights the Malfunction Indicator Lamp (MIL). Some faults require detection for two trips in a row before the MIL is turned on.



The "Malfunction Indicator Lamp" (MIL) is the accepted term used to describe the lamp on the dashboard that lights to warn the driver that an emissions-related fault has been found. Some manufacturers may still call this lamp a "Check Engine" or "Service Engine Soon" light.

There are two types of DTCs used for emissions-related faults: Type "A" and Type "B." Type "A" codes are "One-Trip" codes; Type "B" DTCs are usually Two-Trip DTCs.

When a **Type "A"** DTC is found on the First Trip, the following events take place:

- The computer commands the MIL "On" when the failure is first found.
- If the failure causes a severe misfire that may cause damage to the catalytic converter, the MIL "flashes" **once per second**. The MIL continues to flash as long as the condition exists. If the condition that caused the MIL to flash is no longer present, the MIL will light "steady" On.
- A DTC is saved in the computer's memory for later retrieval.
- A "Freeze Frame" of the conditions present in the engine or emissions system when the MIL was ordered "On" is saved in the computer's memory for later retrieval. This information shows fuel system status (closed loop or open loop), engine load, coolant temperature, fuel trim value, MAP vacuum, engine RPM and DTC priority.

When a **Type "B"** DTC is found on the First Trip, the following events take place:

- The computer sets a Pending DTC, but the MIL is not ordered "On." "Freeze Frame" data may or may not be saved at this time depending on manufacturer. The Pending DTC is saved in the computer's memory for later retrieval.
- If the failure **is found** on the second consecutive trip, the MIL is ordered "On." "Freeze Frame" data is saved in the computer's memory.
- If the failure **is not found** on the second Trip, the Pending DTC is erased from the computer's memory.

The MIL will stay lit for both Type "A" and Type "B" codes until one of the following conditions occurs:

- If the conditions that caused the MIL to light are no longer present for the next three trips in a row, the computer automatically turns the MIL “Off” if no other emissions-related faults are present. However, the DTCs remain in the computer’s memory as a history code for 40 warm-up cycles (80 warm-up cycles for fuel and misfire faults). The DTCs are automatically erased if the fault that caused them to be set is not detected again during that period.
- Misfire and fuel system faults require three trips with “similar conditions” before the MIL is turned “Off.” These are trips where the engine load, RPM and temperature are similar to the conditions present when the fault was first found.



After the MIL has been turned off, DTCs and Freeze Frame data stay in the computer’s memory.

- Erasing the DTCs from the computer’s memory can also turn off the MIL. See ERASING DIAGNOSTIC TROUBLE CODES (DTCs) on page 31, before erasing codes from the computer’s memory. If a Diagnostic Tool or Scan Tool is used to erase the codes, Freeze Frame data will also be erased.

OBD2 MONITORS

To ensure the correct operation of the various emissions-related components and systems, a diagnostic program was developed and installed in the vehicle’s on-board computer. The program has several procedures and diagnostic strategies. Each procedure or diagnostic strategy is made to monitor the operation of, and run diagnostic tests on, a specific emissions-related component or system. These tests ensure the system is running correctly and is within the manufacturer’s specifications. On OBD2 systems, these procedures and diagnostic strategies are called “Monitors.”

Currently, fifteen Monitors are supported by OBD2 systems. Additional monitors may be added as a result of Government regulations as the OBD2 system grows and matures. Not all vehicles support all fifteen Monitors. Additionally, some Monitors are supported by “spark ignition” vehicles only, while others are supported by “compression ignition” vehicles only.

Monitor operation is either “**Continuous**” or “**Non-Continuous**,” depending on the specific monitor.







Continuous Monitors

Three of these Monitors are designed to constantly monitor their associated components and/or systems for proper operation. Continuous Monitors run constantly when the engine is running. The Continuous Monitors are:

- **CCM** Comprehensive Component Monitor (CCM)
- **MIS** Misfire Monitor
- **FUE** Fuel System Monitor





Non-Continuous Monitors

The other twelve Monitors are “non-continuous” Monitors. “Non-continuous” Monitors perform and complete their testing once per trip. The “non-continuous” Monitors are:

-  Oxygen Sensor Monitor
-  Oxygen Sensor Heater Monitor
-  Catalyst Monitor
-  Heated Catalyst Monitor
-  EGR System Monitor
-  EVAP System Monitor
-  Secondary Air System Monitor



The following Monitors will be standard beginning in 2010. The majority of vehicles produced before this time will not support these Monitors

-  NMHC Monitor
-  NOx Adsorber Monitor
-  Boost Pressure System Monitor
-  Exhaust Gas Sensor Monitor
-  PM Filter Monitor

The following provides a brief explanation of the function of each Monitor:

-  **Comprehensive Component Monitor (CCM)** - This Monitor continuously checks all inputs and outputs from sensors, actuators, switches and other devices that provide a signal to the computer. The Monitor checks for shorts, opens, out of range value, functionality and “rationality.”



Rationality: Each input signal is compared against all other inputs and against information in the computer’s memory to see if it makes sense under the current operating conditions. Example: The signal from the throttle position sensor indicates the vehicle is in a wide-open throttle condition, but the vehicle is really at idle, and the idle condition is confirmed by the signals from all other sensors. Based on the input data, the computer determines that the signal from the throttle position sensor is not rational (does not make sense when compared to the other inputs). In this case, the signal would fail the rationality test.

The CCM is supported by both “spark ignition” vehicles and “compression ignition” vehicles. The CCM may be either a “One-Trip” or a “Two-Trip” Monitor, depending on the component.

FUE **Fuel System Monitor** - This Monitor uses a Fuel System Correction program, called Fuel Trim, inside the on-board computer. Fuel Trim is a set of positive and negative values that represent adding or subtracting fuel from the engine. This program is used to correct for a lean (too much air/not enough fuel) or rich (too much fuel/not enough air) air-fuel mixture. The program is designed to add or subtract fuel, as needed, up to a certain percent. If the correction needed is too large and exceeds the time and percent allowed by the program, a fault is indicated by the computer.

The Fuel System Monitor is supported by both “spark ignition” vehicles and “compression ignition” vehicles. The Fuel System Monitor may be a “One-Trip” or “Two-Trip” Monitor, depending on the severity of the problem.

MIS **Misfire Monitor** - This Monitor continuously checks for engine misfires. A misfire occurs when the air-fuel mixture in the cylinder does not ignite. The misfire Monitor uses changes in crankshaft speed to sense an engine misfire. When a cylinder misfires, it no longer contributes to the speed of the engine, and engine speed decreases each time the affected cylinder(s) misfire. The misfire Monitor is designed to sense engine speed fluctuations and determine from which cylinder(s) the misfire is coming, as well as how bad the misfire is. There are three types of engine misfires, Types 1, 2, and 3.

- Type 1 and Type 3 misfires are two-trip monitor faults. If a fault is sensed on the first trip, the computer temporarily saves the fault in its memory as a Pending Code. The MIL is not commanded on at this time. If the fault is found again on the second trip, under similar conditions of engine speed, load and temperature, the computer commands the MIL “On,” and the code is saved in its long term memory.
- Type 2 misfires are the most severe type of misfire. When a Type 2 misfire is sensed on the first trip, the computer commands the MIL to light when the misfire is sensed. If the computer determines that a Type 2 misfire is severe, and may cause catalytic converter damage, it commands the MIL to “flash” once per second as soon as the misfire is sensed. When the misfire is no longer present, the MIL reverts to steady “On” condition.

The Misfire Monitor is supported by both “spark ignition” vehicles and “compression ignition” vehicles.

CAT **Catalyst Monitor** - The catalytic converter is a device that is installed downstream of the exhaust manifold. It helps to oxidize (burn) the unburned fuel (hydrocarbons) and partially burned fuel (carbon monoxide) left over from the combustion process. To accomplish this, heat and catalyst materials inside the converter react with the exhaust gases to burn the remaining fuel. Some materials inside the catalytic converter also have the ability to store oxygen, and release it as needed to oxidize hydrocarbons and carbon monoxide. In the process, it reduces vehicle emissions by converting the polluting gases into carbon dioxide and water.

The computer checks the efficiency of the catalytic converter by monitoring the oxygen sensors used by the system. One sensor is located before (upstream of) the converter; the other is located after (downstream

of) the converter. If the catalytic converter loses its ability to store oxygen, the downstream sensor signal voltage becomes almost the same as the upstream sensor signal. In this case, the monitor fails the test.

The Catalyst Monitor is supported by "spark ignition" vehicles only. The Catalyst Monitor is a "Two-Trip" Monitor. If a fault is found on the first trip, the computer temporarily saves the fault in its memory as a Pending Code. The computer does not command the MIL on at this time. If the fault is sensed again on the second trip, the computer commands the MIL "On" and saves the code in its long-term memory.



Heated Catalyst Monitor - Operation of the "heated" catalytic converter is similar to the catalytic converter. The main difference is that a heater is added to bring the catalytic converter to its operating temperature more quickly. This helps reduce emissions by reducing the converter's down time when the engine is cold. The Heated Catalyst Monitor performs the same diagnostic tests as the catalyst Monitor, and also tests the catalytic converter's heater for proper operation.

The Heated Catalyst Monitor is supported by "spark ignition" vehicles only. This Monitor is also a "Two-Trip" Monitor.



Exhaust Gas Recirculation (EGR) Monitor - The Exhaust Gas Recirculation (EGR) system helps reduce the formation of Oxides of Nitrogen during combustion. Temperatures above 2500°F cause nitrogen and oxygen to combine and form Oxides of Nitrogen in the combustion chamber. To reduce the formation of Oxides of Nitrogen, combustion temperatures must be kept below 2500°F. The EGR system recirculates small amounts of exhaust gas back into the intake manifold, where it is mixed with the incoming air/fuel mixture. This reduces combustion temperatures by up to 500°F. The computer determines when, for how long, and how much exhaust gas is recirculated back to the intake manifold. The EGR Monitor performs EGR system function tests at preset times during vehicle operation.

The EGR Monitor is supported by both "spark ignition" vehicles and "compression ignition" vehicles. The EGR Monitor is a "Two-Trip" Monitor. If a fault is found on the first trip, the computer temporarily saves the fault in its memory as a Pending Code. The computer does not command the MIL on at this time. If the fault is sensed again on the second trip, the computer commands the MIL "On," and saves the code in its long-term memory.



Evaporative System (EVAP) Monitor - OBD2 vehicles are equipped with a fuel Evaporative system (EVAP) that helps prevent fuel vapors from evaporating into the air. The EVAP system carries fumes from the fuel tank to the engine where they are burned during combustion. The EVAP system may consist of a charcoal canister, fuel tank cap, purge solenoid, vent solenoid, flow monitor, leak detector and connecting tubes, lines and hoses.

Fumes are carried from the fuel tank to the charcoal canister by hoses or tubes. The fumes are stored in the charcoal canister. The computer controls the flow of fuel vapors from the charcoal canister to the engine via a purge solenoid. The computer energizes or de-energizes the purge

solenoid (depending on solenoid design). The purge solenoid opens a valve to allow engine vacuum to draw the fuel vapors from the canister into the engine where the vapors are burned. The EVAP Monitor checks for proper fuel vapor flow to the engine, and pressurizes the system to test for leaks. The computer runs this Monitor once per trip.

The EVAP Monitor is supported by "spark ignition" vehicles only. The EVAP Monitor is a "Two-Trip" Monitor. If a fault is found on the first trip, the computer temporarily saves the fault in its memory as a Pending Code. The computer does not command the MIL on at this time. If the fault is sensed again on the second trip, the PCM commands the MIL "On," and saves the code in its long-term memory.

HTR **Oxygen Sensor Heater Monitor** - The Oxygen Sensor Heater Monitor tests the operation of the oxygen sensor's heater. There are two modes of operation on a computer-controlled vehicle: "open-loop" and "closed-loop." The vehicle operates in open-loop when the engine is cold, before it reaches normal operating temperature. The vehicle also goes to open-loop mode at other times, such as heavy load and full throttle conditions. When the vehicle is running in open-loop, the oxygen sensor signal is ignored by the computer for air/fuel mixture corrections. Engine efficiency during open-loop operation is very low, and results in the production of more vehicle emissions.

Closed-loop operation is the best condition for both vehicle emissions and vehicle operation. When the vehicle is operating in closed-loop, the computer uses the oxygen sensor signal for air/fuel mixture corrections.

In order for the computer to enter closed-loop operation, the oxygen sensor must reach a temperature of at least 600°F. The oxygen sensor heater helps the oxygen sensor reach and maintain its minimum operating temperature (600°F) more quickly, to bring the vehicle into closed-loop operation as soon as possible.

The Oxygen Sensor Heater Monitor is supported by "spark ignition" vehicles only. The Oxygen Sensor Heater Monitor is a "Two-Trip" Monitor. If a fault is found on the first trip, the computer temporarily saves the fault in its memory as a Pending Code. The computer does not command the MIL on at this time. If the fault is sensed again on the second trip, the computer commands the MIL "On," and saves the code in its long-term memory.

O2S **Oxygen Sensor Monitor** - The Oxygen Sensor monitors how much oxygen is in the vehicle's exhaust. It generates a varying voltage of up to one volt, based on how much oxygen is in the exhaust gas, and sends the signal to the computer. The computer uses this signal to make corrections to the air/fuel mixture. If the exhaust gas has a large amount of oxygen (a lean air/fuel mixture), the oxygen sensor generates a "low" voltage signal. If the exhaust gas has very little oxygen (a rich mixture condition), the oxygen sensor generates a "high" voltage signal. A 450mV signal indicates the most efficient, and least polluting, air/fuel ratio of 14.7 parts of air to one part of fuel.

The oxygen sensor must reach a temperature of at least 600-650°F, and the engine must reach normal operating temperature, for the computer to enter into closed-loop operation. The oxygen sensor only

functions when the computer is in closed-loop. A properly operating oxygen sensor reacts quickly to any change in oxygen content in the exhaust stream. A faulty oxygen sensor reacts slowly, or its voltage signal is weak or missing.

The Oxygen Sensor Monitor is supported by “spark ignition” vehicles only. The Oxygen Sensor Monitor is a “Two-Trip” monitor. If a fault is found on the first trip, the computer temporarily saves the fault in its memory as a Pending Code. The computer does not command the MIL on at this time. If the fault is sensed again on the second trip, the computer commands the MIL “On,” and saves the code in its long-term memory.



Secondary Air System Monitor - When a cold engine is first started, it runs in open-loop mode. During open-loop operation, the engine usually runs rich. A vehicle running rich wastes fuel and creates increased emissions, such as carbon monoxide and some hydrocarbons. A Secondary Air System injects air into the exhaust stream to aid catalytic converter operation:

1. It supplies the catalytic converter with the oxygen it needs to oxidize the carbon monoxide and hydrocarbons left over from the combustion process during engine warm-up.
2. The extra oxygen injected into the exhaust stream also helps the catalytic converter reach operating temperature more quickly during warm-up periods. The catalytic converter must heat to operating temperature to work properly.

The Secondary Air System Monitor checks for component integrity and system operation, and tests for faults in the system. The computer runs this Monitor once per trip.

The Secondary Air System Monitor is a “Two-Trip” monitor. If a fault is found on the first trip, the computer temporarily saves this fault in its memory as a Pending Code. The computer does not command the MIL on at this time. If the fault is sensed again on the second trip, the computer commands the MIL “On,” and saves the code in its long-term memory.



Non-Methane Hydrocarbon Catalyst (NMHC) Monitor - The non-methane hydrocarbon catalyst is a type of catalytic converter. It helps to remove non-methane hydrocarbons (NMH) left over from the combustion process from the exhaust stream. To accomplish this, heat and catalyst materials react with the exhaust gases to convert NMH to less harmful compounds. The computer checks the efficiency of the catalyst by monitoring the quantity of NMH in the exhaust stream. The monitor also verifies that sufficient temperature is present to aid in particulate matter (PM) filter regeneration.

The NMHC Monitor is supported by “compression ignition” vehicles only. The NMHC Monitor is a “Two-Trip” Monitor. If a fault is found on the first trip, the computer temporarily saves the fault in its memory as a Pending Code. The computer does not command the MIL on at this time. If the fault is sensed again on the second trip, the computer commands the MIL “On,” and saves the code in its long-term memory.

NOx **NOx Aftertreatment Monitor** - NOx aftertreatment is based on a catalytic converter support that has been coated with a special washcoat containing zeolites. NOx Aftertreatment is designed to reduce oxides of nitrogen emitted in the exhaust stream. The zeolite acts as a molecular "sponge" to trap the NO and NO₂ molecules in the exhaust stream. In some implementations, injection of a reactant before the aftertreatment purges it. NO₂ in particular is unstable, and will join with hydrocarbons to produce H₂O and N₂. The NOx Aftertreatment Monitor monitors the function of the NOx aftertreatment to ensure that tailpipe emissions remain within acceptable limits.

The NOx Aftertreatment Monitor is supported by "compression ignition" vehicles only. The NOx Aftertreatment Monitor is a "Two-Trip" Monitor. If a fault is found on the first trip, the computer temporarily saves the fault in its memory as a Pending Code. The computer does not command the MIL on at this time. If the fault is sensed again on the second trip, the computer commands the MIL "On," and saves the code in its long-term memory.

BPS **Boost Pressure System Monitor** - The boost pressure system serves to increase the pressure produced inside the intake manifold to a level greater than atmospheric pressure. This increase in pressure helps to ensure compete combustion of the air-fuel mixture. The Boost Pressure System Monitor checks for component integrity and system operation, and tests for faults in the system. The computer runs this Monitor once per trip.

The Boost Pressure System Monitor is supported by "compression ignition" vehicles only. The Boost Pressure System Monitor is a "Two-Trip" Monitor. If a fault is found on the first trip, the computer temporarily saves the fault in its memory as a Pending Code. The computer does not command the MIL on at this time. If the fault is sensed again on the second trip, the computer commands the MIL "On," and saves the code in its long-term memory.

EGS **Exhaust Gas Sensor Monitor** - The exhaust gas sensor is used by a number of systems/monitors to determine the content of the exhaust stream. The computer checks for component integrity, system operation, and tests for faults in the system, as well as feedback faults that may affect other emission control systems.

The Exhaust Gas Sensor Monitor is supported by "compression ignition" vehicles only. The Exhaust Gas Sensor Monitor is a "Two-Trip" Monitor. If a fault is found on the first trip, the computer temporarily saves the fault in its memory as a Pending Code. The computer does not command the MIL on at this time. If the fault is sensed again on the second trip, the computer commands the MIL "On," and saves the code in its long-term memory.



PM Filter Monitor - The particulate matter (PM) filter removes particulate matter from the exhaust stream by filtration. The filter has a honeycomb structure similar to a catalyst substrate, but with the channels blocked at alternate ends. This forces the exhaust gas to flow through the walls between the channels, filtering the particulate matter out. The filters are self-cleaning by periodic modification of the exhaust gas concentration in order to burn off the trapped particles (oxidizing the particles to form CO₂ and water). The computer monitors the efficiency of the filter in trapping particulate matter, as well as the ability of the filter to regenerate (self-clean).

The PM Filter Monitor is supported by “compression ignition” vehicles only. The PM Filter Monitor is a “Two-Trip” Monitor. If a fault is found on the first trip, the computer temporarily saves the fault in its memory as a Pending Code. The computer does not command the MIL on at this time. If the fault is sensed again on the second trip, the computer commands the MIL “On,” and saves the code in its long-term memory.

OBD2 Reference Table

The table below lists current OBD2 Monitors, and indicates the following for each Monitor:

- A. Monitor Type (how often does the Monitor run; Continuous or Once per trip)
- B. Number of trips needed, with a fault present, to set a pending DTC
- C. Number of consecutive trips needed, with a fault present, to command the MIL “On” and store a DTC
- D. Number of trips needed, with no faults present, to erase a Pending DTC
- E. Number and type of trips or drive cycles needed, with no faults present, to turn off the MIL
- F. Number of warm-up periods needed to erase the DTC from the computer’s memory after the MIL is turned off

Name of Monitor	A	B	C	D	E	F
Comprehensive Component Monitor	Continuous	1	2	1	3	40
Misfire Monitor (Type 1 and 3)	Continuous	1	2	1	3 - similar conditions	80
Misfire Monitor (Type 2)	Continuous		1		3 - similar conditions	80
Fuel System Monitor	Continuous	1	1 or 2	1	3 - similar conditions	80
Catalytic Converter Monitor	Once per trip	1	2	1	3 trips	40
Oxygen Sensor Monitor	Once per trip	1	2	1	3 trips	40
Oxygen Sensor Heater Monitor	Once per trip	1	2	1	3 trips	40
Exhaust Gas Recirculation (EGR) Monitor	Once per trip	1	2	1	3 trips	40
Evaporative Emissions Controls Monitor	Once per trip	1	2	1	3 trips	40
Secondary Air System (AIR) Monitor	Once per trip	1	2	1	3 trips	40
NMHC Monitor	Once per trip	1	2	1	3 trips	40
NOx Adsorber Monitor	Once per trip	1	2	1	3 trips	40
Boost Pressure System Monitor	Once per trip	1	2	1	3 trips	40
Exhaust Gas Sensor Monitor	Once per trip	1	2	1	3 trips	40
PM Filter Monitor	Once per trip	1	2	1	3 trips	40

BEFORE YOU BEGIN

Fix any known mechanical problems before performing any test. See your vehicle's service manual or a mechanic for more information. Check the following areas **before** starting any test:

- Check the engine oil, power steering fluid, transmission fluid (if applicable), engine coolant and other fluids for proper levels. Top off low fluid levels if needed.
- Make sure the air filter is clean and in good condition. Make sure all air filter ducts are properly connected. Check the air filter ducts for holes, rips or cracks.
- Make sure all engine belts are in good condition. Check for cracked, torn, brittle, loose or missing belts.
- Make sure mechanical linkages to engine sensors (throttle, gearshift position, transmission, etc.) are secure and properly connected. See your vehicle's service manual for locations.
- Check all rubber hoses (radiator) and steel hoses (vacuum/fuel) for leaks, cracks, blockage or other damage. Make sure all hoses are routed and connected properly.
- Make sure all spark plugs are clean and in good condition. Check for damaged, loose, disconnected or missing spark plug wires.
- Make sure the battery terminals are clean and tight. Check for corrosion or broken connections. Check for proper battery and charging system voltages.
- Check all electrical wiring and harnesses for proper connection. Make sure wire insulation is in good condition, and there are no bare wires.
- Make sure the engine is mechanically sound. If needed, perform a compression check, engine vacuum check, timing check (if applicable), etc.

VEHICLE SERVICE MANUALS

Always refer to the manufacturer's service manual for your vehicle before performing any test or repair procedures. Contact your local car dealership, auto parts store or bookstore for availability of these manuals. The following companies publish valuable repair manuals:

- **Haynes Publications** - 861 Lawrence Drive, Newbury Park, CA 91320 Phone: 800-442-9637 Web: www.haynes.com
- **Mitchell 1** - 14145 Danielson Street, Poway, CA 92064 Phone: 888-724-6742 Web: www.m1products.com
- **Motor Publications** - 5600 Crooks Road, Suite 200 , Troy, MI 48098 Phone: 800-426-6867 Web: www.motor.com

FACTORY SOURCES

Ford, GM, Chrysler, Honda, Isuzu, Hyundai and Subaru Service Manuals

- **Helm Inc.** - 14310 Hamilton Avenue, Highland Park, MI 48203 Phone: 800-782-4356 Web: www.helminc.com

CODE RETRIEVAL PROCEDURE

Never replace a part based only on the DTC definition. Each DTC has a set of testing procedures, instructions and flow charts that must be followed to confirm the location of the problem. This information is found in the vehicle's service manual. Always refer to the vehicle's service manual for detailed testing instructions.



Check your vehicle thoroughly before performing any test. See **Preparation for Testing** on page 25 for details.



ALWAYS observe safety precautions whenever working on a vehicle. See **Safety Precautions** on page 2 for more information.

1. Turn the ignition off.
2. Locate the vehicle's 16-pin Data Link Connector (DLC). See page 3 for connector location.



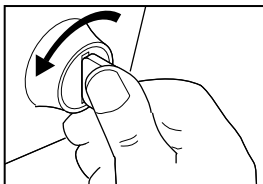

Some DLCs have a plastic cover that must be removed before connecting the Scan Tool cable connector.

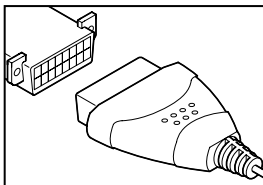

3. Connect the Scan Tool's cable connector to the vehicle's DLC. The cable connector is keyed and will only fit one way.

- If you have problems connecting the cable connector to the DLC, rotate the connector 180° and try again.
- If you still have problems, check the DLC on the vehicle and on the Scan Tool. Refer to your vehicle's service manual to properly check the vehicle's DLC.



- After the Scan Tool's test connector is properly connected to the vehicle's DLC, the Vehicle icon  should display to confirm a good power connection.

4. Turn the ignition on. **DO NOT** start the engine.
5. When the Scan Tool's cable connector is properly connected to the vehicle's DLC, the unit automatically turns ON.

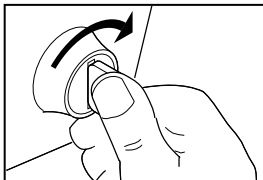

- If the unit does not power on automatically when connected to the vehicle's DLC connector, it usually indicates there is no power present at the vehicle's DLC connector. Check your fuse panel and replace any burned-out fuses.
- If replacing the fuse(s) does not correct the problem, consult your vehicle's repair manual to identify the proper computer (PCM) fuse/circuit, and perform any necessary repairs before proceeding.

- The Scan Tool will automatically start a check of the vehicle's computer to determine which type of communication protocol it is using. When the Scan Tool identifies the computer's communication protocol, a communication link is established.



A **PROTOCOL** is a set of rules and procedures for regulating data transmission between computers, and between testing equipment and computers. As of this writing, five different types of protocols (ISO 9141, Keyword 2000, J1850 PWM, J1850 VPW and CAN) are in use by vehicle manufacturers. The Scan Tool automatically identifies the protocol type and establishes a communication link with the vehicle's computer.



- If the Scan Tool fails to link to the vehicle's computer a "Communication Error" message shows on the Scan Tool's display.
 - Ensure the vehicle is OBD2 compliant. See **VEHICLES COVERED** on page 3 for vehicle compliance verification information.
 - Verify the connection at the DLC, and verify the ignition is ON.
 - Turn the ignition OFF, wait five seconds, then turn back ON to reset the computer.
 - Press the **ENTER** button to continue.
- If the Scan Tool cannot link to the vehicle's computer after three attempts, the message "Contact Technical Support" displays.
 - Press and hold the **ENTER** button to return to the Main Menu.
 - Turn the ignition off, and disconnect the Scan Tool.
 - Contact Technical Support for assistance.

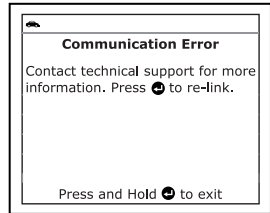
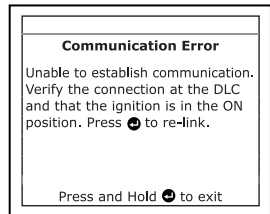

- After approximately 10~60 seconds, the Scan Tool will **retrieve** and **display** any Diagnostic Trouble Codes, Monitor Status and Freeze Frame Data retrieved from the vehicle's computer memory.

- The Scan Tool will display a code only if codes are present in the vehicle's computer memory. If no codes are present, a "No DTC's or Freeze Frame data presently stored in the vehicle's computer" message is displayed.

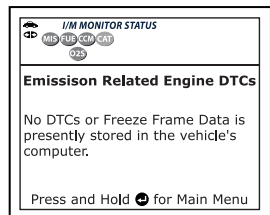

- The Scan Tool is capable of retrieving and storing up to 32 codes in memory, for immediate or later viewing.

8. To read the display:



Refer to **DISPLAY FUNCTIONS** on page 5 for a description of display elements.

- A visible icon indicates that the Scan Tool is being powered through the vehicle's DLC connector.
- A visible icon indicates that the Scan Tool is linked to (communicating with) the vehicle's computer.
- The I/M Monitor Status icons indicate the type and number of Monitors the vehicle supports, and provides indications of the current status of the vehicle's Monitors. A **solid** Monitor icon indicates the associated Monitor **has run** and completed its testing. A **blinking** Monitor icon indicates the associated Monitor **has not** run and completed its testing.
- The top line in the Test Data Display Area shows the DTC, the number of the code currently being displayed and the total number of codes retrieved, and the type of code being displayed (Generic Stored, Generic Pending, Generic Permanent, etc).
- The upper right hand corner shows whether or not the displayed code commanded the MIL on and whether Freeze Frame data was stored for the "priority" code.
- The Diagnostic Trouble Code (DTC) and related code definition are shown in the lower section of the display.

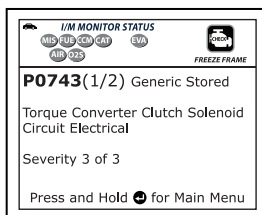

In the case of long code definitions, or when viewing Freeze Frame Data, a small arrow is shown in the upper/lower right-hand corner of the Scan Tool display area to indicate the presence of additional information. Use the button, as necessary, to view the additional information.



If a definition for the currently displayed code is not available, an advisory message shows on the Scan Tool's display.

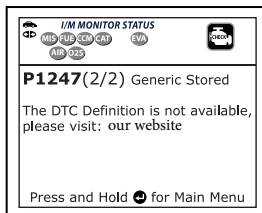

9. Read and interpret the Diagnostic Trouble Codes using the LCD display and the green, yellow and red LEDs.



The green, yellow and red LEDs are used (with the LCD display) as visual aids to make it easier to determine engine system conditions.

- **Green LED** – Indicates that all engine systems are “OK” and operating normally. All monitors supported by the vehicle have run and performed their diagnostic testing, and no trouble codes are present. All Monitor icons will be solid.

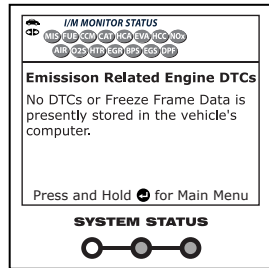

- **Yellow LED** - Indicates one of the following conditions:

- A **PENDING CODE IS PRESENT** – If the yellow LED is illuminated, it may indicate a Pending code is present. Check the Scan Tool's display for confirmation. A Pending code is confirmed by the presence of a numeric code and the word “Pending” in the code type.

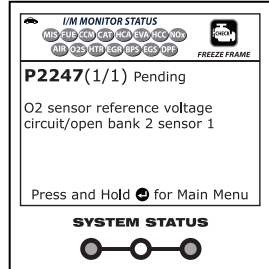

- MONITOR NOT RUN STATUS** – If the Scan Tool's display shows a zero (indicating there are no DTC's present in the vehicle's computer memory), but the yellow LED is illuminated, it may be an indication that some of the Monitors supported by the vehicle have not yet run and completed their diagnostic testing. Check the Scan Tool's display for confirmation. All Monitor icons that are **blinking** have not yet run and completed their diagnostic testing; all Monitor icons that are solid have run and completed their diagnostic testing.

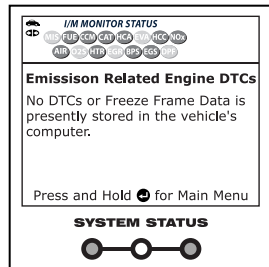

- **Red LED** – Indicates there is a problem with one or more of the vehicle's systems. The red LED is also used to indicate that DTC(s) are present (displayed on the Scan Tool's screen). In this case, the Malfunction Indicator (Check Engine) lamp on the vehicle's instrument panel will be illuminated.

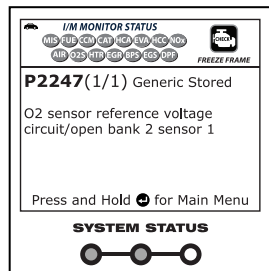

- DTC's that start with “P0”, “P2” and some “P3” are considered Generic (Universal). All Generic DTC definitions are the same on all OBD2 equipped vehicles. The Scan Tool automatically displays the code definitions (if available) for Generic DTC's.

- DTC's that start with "P1" and some "P3" are Manufacturer specific codes and their code definitions vary with each vehicle manufacturer. When a Manufacturer specific DTC is retrieved, the LCD display shows a list of vehicle manufacturers. Use the **DOWN** ▼ button, as necessary, to highlight the appropriate manufacturer, then press the **ENTER** ↵ button to display the correct code definition for your vehicle. A confirmation message shows on the Scan Tool's display.

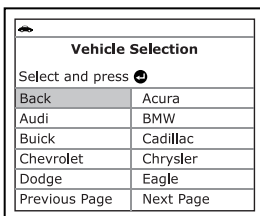

- If the correct manufacturer is shown, use the **DOWN** ▼ button, as necessary, to highlight **Yes**, then press the **ENTER** ↵ button.
- If the correct manufacturer is not shown, use the **DOWN** ▼ button, as necessary, to highlight **No**, then press the **ENTER** ↵ button to return to the list of manufacturers.

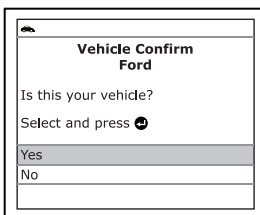

*If the manufacturer for your vehicle is not shown, select **Previous Page** or **Next Page** and press the **ENTER** ↵ button to view other pages of the list.*

- If more than one DTC was retrieved, and to view Freeze Frame Data, press and release the **DTC/FF** button, as necessary.
 - Each time the **DTC/FF** button is pressed and released, the Scan Tool will scroll and display the next DTC in sequence until all DTCs in its memory have displayed.
 - Freeze Frame Data (if available) will display after DTC #1
 - In OBD2 systems, when an emissions-related engine malfunction occurs that causes a DTC to set, a record or snapshot of engine conditions at the time that the malfunction occurred is also saved in the vehicle's computer memory. The record saved is called Freeze Frame data. Saved engine conditions include, but are not limited to: engine speed, open or closed loop operation, fuel system commands, coolant temperature, calculated load value, fuel pressure, vehicle speed, air flow rate, and intake manifold pressure.

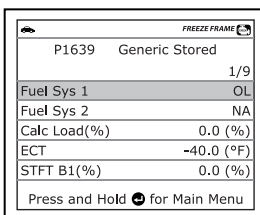

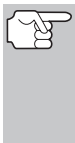

If more than one malfunction is present that causes more than one DTC to be set, only the code with the highest priority will contain Freeze Frame data. The code designated "01" on the Scan Tool display is referred to as the PRIORITY code, and Freeze Frame data always refers to this code. The priority code is also the one that has commanded the MIL on.



Retrieved information can be uploaded to a Personal Computer (PC) with the use of optional software (see instructions included with the software for more information).

11. When the last retrieved DTC has been displayed and the **DTC/FF** button is pressed, the Scan Tool returns to the "Priority" Code.
12. Determine engine system(s) condition by viewing the Scan Tool's display for any retrieved Diagnostic Trouble Codes, code definitions and Freeze Frame data, and interpreting the green, yellow and red LEDs.
 - If DTC's were retrieved and you are going to perform the repairs yourself, proceed by consulting the Vehicle's Service Repair Manual for testing instructions, testing procedures, and flow charts related to retrieved code(s).

ERASING DIAGNOSTIC TROUBLE CODES (DTCs)



When the Scan Tool's ERASE function is used to erase the DTCs from the vehicle's on-board computer, "Freeze Frame" data and manufacturer-specific enhanced data are also erased.

If you plan to take the vehicle to a Service Center for repair, **DO NOT** erase the codes from the vehicle's computer. If the codes are erased, valuable information that might help the technician troubleshoot the problem will also be erased.



Erase DTCs from the computer's memory as follows:

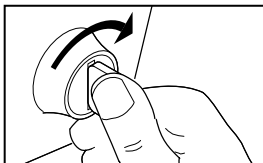
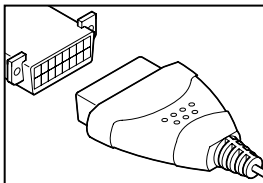

When DTCs are erased from the vehicle's computer memory, the I/M Readiness Monitor Status program resets status of all the Monitors to a not run "flashing" condition. To set all of the Monitors to a DONE status, an OBD2 Drive Cycle must be performed. Refer to your vehicle's service manual for information on how to perform an OBD2 Drive Cycle for the vehicle under test.

1. If not connected already, connect the Scan Tool to the vehicle's DLC. (If the Scan Tool is already connected and linked to the vehicle's computer, proceed directly to step 4. If not, continue to step 2.)
2. Turn the ignition on. **DO NOT** start the engine. The Scan Tool will automatically link to the vehicle's computer.
3. Once codes have been retrieved, press and release the Scan Tool's **ERASE**  button. A confirmation message shows on the display.



- If you change your mind and do not wish to erase the codes, use the **DOWN** ▼ button, as necessary, to highlight **No**, then press the **ENTER** ← button.
 - If you wish to continue, use the **DOWN** ▼ button, as necessary, to highlight **Yes**, then press the **ENTER** ← button.
4. A “One moment please...” message displays while the erase function is in progress.
- If the engine is running, an advisory dialog displays. Turn the engine off, place the ignition in the ON position, then press the **ERASE**  button to continue.
 - If the erase was successful, a confirmation message shows on the display. The Tool will relink to the vehicle and display the DTC screen.
 - If the erase was not successful and ECU error code \$22 is present, an advisory message shows on the display. Start the engine, hold vehicle speed at 0, then press the **ERASE**  button to continue.
 - If the erase was not successful and ECU error code \$22 is not present, an advisory message shows on the display. Verify that the Scan Tool is properly connected to the vehicle's DLC and that the ignition is on, then press the **ERASE**  button to continue.



Erasing DTCs does not fix the problem(s) that caused the code(s) to be set. If proper repairs to correct the problem that caused the code(s) to be set are not made, the code(s) will appear again (and the check engine light will illuminate) as soon as the vehicle is driven long enough for its Monitors to complete their testing.

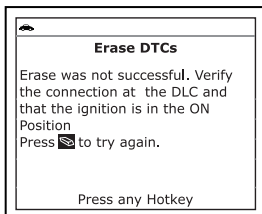
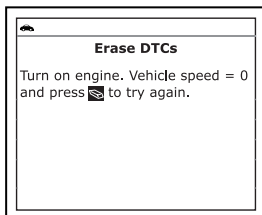
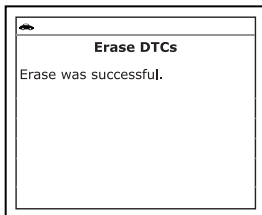
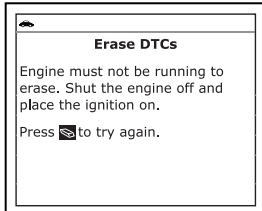
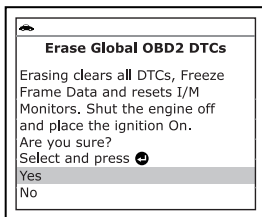

ABOUT REPAIRSOLUTIONS®

RepairSolutions® is a web-based service that provides you with the tools and information you need to quickly and accurately diagnose and repair today's vehicles. RepairSolutions® lets you view, save, and email the diagnostic data retrieved from a vehicle's on-board computer(s) using an Innova Scan Tool. At the core of RepairSolutions® is an extensive knowledge database, developed by compiling and analyzing years worth of "real world" vehicle service data. RepairSolutions® builds on manufacturer-recommended diagnostic and repair information by providing verified, vehicle-specific fixes supplied by ASE technicians across the country. The basic RepairSolutions® account is free, and is available immediately upon purchase of your Innova tool and a one-time software download. Certain "value added" premium information is available on demand at nominal charge or through "premium" subscription.

The RepairSolutions® Diagnostic Report

The RepairSolutions® Diagnostic Report provides you with detailed information for diagnosing and repairing vehicle issues. The Diagnostic Report gives you the following information:



Some features are available only with a "premium" subscription to RepairSolutions®.

- **Summary** – The **Summary** page shows the current status of your vehicle's emissions, engine/transmission, supplemental restraint (airbag) and anti-lock brake systems, and provides a summary of the issues associated with your vehicle.
- **Verified Fixes** – The **Verified Fixes** page lists the most likely repair(s) needed by your vehicle based on the DTCs retrieved. It includes cost estimates for the repair(s) based on your geographic location, provides access to detailed instructions for performing the repair(s), and includes links to supplemental information (including articles and videos) related to the affected component or system.
- **Diagnostic Data** – The **Diagnostic Data** page provides detailed information related to the DTCs retrieved from your vehicle's computer. It includes descriptions of the retrieved DTCs including the conditions under which each DTC was set, the probable causes for the issue and recommendations for verifying the problem. You can also view Freeze Frame data for the "priority" DTC (the DTC that caused the MIL to illuminate) and current I/M Monitor status.
- **TSBs / Recalls** - Even with the exhaustive testing a vehicle undergoes before being made available to the public, some issues are discovered only under "real world" driving conditions. Depending on the severity of the problem, the vehicle manufacturer may issue a Technical Service Bulletin describing the problem, and providing the procedures necessary to correct it. For safety related problems, vehicle manufacturers are required to issue vehicle recalls to correct the problem. The **TSBs / Recalls** page lists three main categories for issues related to your vehicle: Factory Technical Service Bulletins (TSBs), Factory Recalls, and Government-mandated NHTSA Safety Recalls. This information can help you identify a problem before it occurs, and ensure your vehicle meets Federal safety standards.

- **Maintenance** - The **Maintenance** page provides information to help keep your vehicle in top running condition. The page uses your vehicle's year, make, model and current mileage to provide a list of manufacturer-recommended periodic maintenance procedures that should be performed during its next scheduled service. These maintenance items are highly recommended and should be performed to best protect against premature failure. The page also includes additional recommended service procedures based on analysis of component failures reported by the RepairSolutions® network of technicians for vehicles of your make, model and mileage. All procedures include estimates of cost and level of difficulty.
- **Warranty** – Warranties are the vehicle manufacturer's promise to cover certain repair/replacement costs for a specific amount of time or until the vehicle has been driven for a specific number of miles. The **Warranty** page provides an estimation of the current state of your vehicle's warranties (whether they are active, expired, and/or transferable). This information is intended for reference only. It is based on manufacturer published data available at the time the data was gathered and may not fully reflect your actual warranty coverage.
- **Predicted Repairs** – Solving a problem before it becomes a problem can reduce out-of-pocket cost and minimize personal inconvenience. Through detailed analysis of historical repair information supplied by technician across the country, RepairSolutions® is able to provide highly accurate predictions of potential service and repair requirements based on your vehicle's year, make, model and mileage. The **Predicted Repairs** page provides a list of predicted repairs for your vehicle over the next 12 months. The predicted repairs are weighted by probability (high, moderate or low) and include cost estimates.
- **Vehicle History Reports** – Thinking of buying a vehicle? RepairSolutions® provides “one click” access for the purchase of a vehicle history report.

The Portal Page

The **Portal** page gives you an overview of your RepairSolutions® account. It shows your Account Status and provides access to the reports you have most recently generated using a registered Innova tool.

Innova Account

The **Innova Account** section lets you manage the vehicles and tools you've registered with your account and manage your personal information.

- **My Garage** – Your RepairSolutions® account can be used for multiple vehicles. The **My Garage** page you add, view and edit vehicles for your account.
- **Report History** – Each report you create through RepairSolutions® is retained through the lifetime of your membership, giving you an overview of the health of your vehicles. The **Report History** page lets you browse a list of all reports created through RepairSolutions® for

all vehicles registered to your account, and view any report listed. You can also search the list based on the criteria (report #, VIN, etc.) you specify.

- **Registered Devices** – You can register all of your Innova tools with your RepairSolutions® account. The **Registered Devices** page shows all the tools registered to your account along with the date on which the device was activated.
- **Order History** – You can purchase “premium” access to RepairSolutions® on a monthly or annual basis. The **Order History** page lists all subscriptions you’ve purchased for your account.
- **Profile and Reset Password** – These pages let you update and maintain your personal account information and change the password you use to log in to RepairSolutions®.

Tools

The RepairSolutions® **Tools** section provides access to several databases offering maintenance and repair instruction, “tech tips,” safety information and general reference data.

- **How-To Videos** – With the complexity of today’s vehicles, repair tasks can seem daunting even to the seasoned do-it-yourselfer. RepairSolutions® offers a rich selection of **How-To Videos** that provide step-by-step instruction for a variety of tasks, including general maintenance, diagnosis and troubleshooting, and detailed repair information. The “basic” membership provides access to a selection of available videos, while the “premium” subscription allows access to the complete video library.
- **Recalls** – Even with the exhaustive testing a vehicle undergoes before being made available to the public, some issues are discovered only under “real world” driving conditions. When an issue that affects personal safety is found, or if a vehicle does not meet Federal safety standards, the Government mandates that the vehicle manufacturer issue a “safety recall.” Safety recalls are official notices that describe known vehicle issues as well as the related safety concerns. Repairs performed to address a safety recall are provided free of cost by the vehicle manufacturer’s dealership. The **Recalls** database helps you ensure the safety of your vehicle. You can search for safety recalls by entering a vehicle’s year, make and model.
- **DTC Library** – Diagnostic Trouble Codes (DTCs) are the starting point for identifying, troubleshooting and repairing vehicle issues. The **DTC Library** contains definitions for “generic” and “manufacturer-specific” OBD2 DTCs as well as OBD1 codes. Currently, the database provides code definitions for 43 different vehicle makes. Select the desired make and enter the DTC to retrieve the specific definition for your vehicle. Because OBD2 is an evolving system, the **DTC Library** is continuously updated to include additional “manufacturer-specific” definitions as the system matures.
- **DLC Locator** – The key to unlocking the wealth of information available through OBD2 is the Data Link Connector (DLC), the

doorway to your vehicle's computer. The **DLC Locator** is a comprehensive database of DLC locations for all OBD2-certified vehicles. Simply enter a Vehicle Identification Number (VIN), or select the desired year, make and model, and the **DLC Locator** will return a description and photo illustration of the DLC location.

- **Tech Tips** – Updated quarterly, RepairSolutions® **Tech Tips** are designed to provide basic solutions to everyday vehicle issues, explain how to perform much needed maintenance, and provide basic information on how to take care of your vehicle. All **Tech Tips** are prepared, reviewed and approved with the support of ASE Certified Technicians.
- **Shop Locator** – Whether you want to purchase parts to make a repair yourself or find a local repair shop, the **Shop Locator** will return a list facilities near your location based on the Zip Code you provide.

Minimum System Operating Requirements:

- Windows®

OS Requirements

- Windows® XP / Windows® Vista (32/64-bit editions) / Windows® 7 (32/64-bit editions) / Windows® 8 / Windows® 8.1

Minimum Hardware Requirements

- 50 MB free disk space
- 128 MB RAM
- Pentium processor or better
- One available USB port (USB 2.0 preferred)

Other Requirements

- Internet Connection
- Internet Explorer 5.5, Netscape 7.0 or Firefox 2.0 browser or newer

- MAC®

OS Requirements

- Mac OS 10.4.4 and newer

Minimum Hardware Requirements

- 100 MB free disk space
- 256 MB of RAM
- Intel PowerPC G3, G4 or G5 processor running at 700 MHz or greater
- One available USB port

Other Requirements

- Internet Connection
- Safari 3.0, Netscape 7.2 or Firefox 3.0 browser or newer

Accessing RepairSolutions®

1. Link your Scan Tool to a vehicle and retrieve diagnostic data.
2. Visit www.pro.innova.com, download and install the latest PC-Link software for your Scan Tool. Select the **Support** tab, then choose **Manuals and Software**. Use the drop-down menu provided to select your tool Category and tool Model to download the latest PC-Link software.
3. Connect the Scan Tool to your PC using a Mini USB cable (cable included).
 - Your default web browser launches automatically and connects to the www.pro.innova.com website.
4. Login to your RepairSolutions® account using your registered **Email Address** and **Password**.



If you have not yet established an account, you must register for a FREE RepairSolutions® account before proceeding.



THE MAIN MENU

In addition to retrieving Diagnostic Trouble Codes (DTCs), you can use the Scan Tool to perform additional diagnostic tests, to view diagnostic and vehicle information stored in your vehicle's on-board computer, and to configure the Scan Tool for your particular needs. Additional tests and related functions are accessed through the Main Menu. The following functions are available:

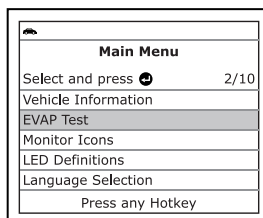
- **EVAP Test** - Performs a leak test for the vehicle's EVAP system.
- **Monitor Icons** – Shows the full names for the **I/M MONITOR STATUS** icons shown on the Scan Tool's display.
- **LED Meaning** – Provides descriptions of the meaning of the Scan Tool **SYSTEM STATUS** LEDs.
- **Language Selection**: Sets the display language for the Scan Tool to English, French or Spanish.
- **Adjust Brightness**: Adjusts the brightness of the display screen.
- **Audible Tone**: Turns the Scan Tool's audible tone "on" and "off." When turned "on," a tone sounds each time a button is pressed.
- **Footer**: Turns the navigational "footers" at the bottom of most display screens "on" and "off."
- **Hotkeys Legends**: Shows functional descriptions for the Scan Tool's hotkeys.
- **Unit of Measurement**: Sets the Unit of Measurement for the Scan Tool's display to USA or metric.



To access the Main Menu:

1. While linked to the vehicle, press and hold the **ENTER**  button.
 - The Main Menu displays.
2. Use the **DOWN**  button, as necessary, to select the desired option, then press the **ENTER**  button.
3. Available functions are described in the following paragraphs.

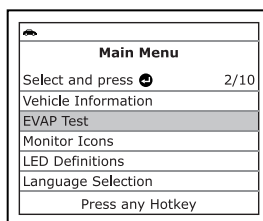

EVAP TEST

The **EVAP Test** function lets you initiate a leak test for the vehicle's EVAP system.



*The Scan Tool does not perform the leak test, but signals to vehicle's on-board computer to initiate the test. The vehicle manufacturer determines the criteria and method for stopping the test once it has been started. BEFORE using the **EVAP Test** function, refer to the vehicle's service repair manual to determine the procedures necessary to stop the test.*

1. From the Main Menu, use the **DOWN** ▼ button as necessary, to highlight **EVAP Test**, then press the **ENTER** ⏏ button.
2. A "One moment please..." message displays while the request is sent to the vehicle's on-board computer.

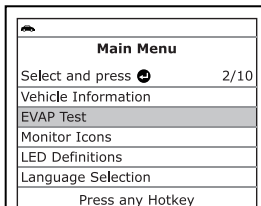

*Some vehicle manufacturers do not allow Scan Tools or other external devices to control vehicle systems. If the **EVAP Test** is not supported by the vehicle under test, an advisory message shows on the Scan Tool's display. Press the **ENTER** ⏏ button to return to the Main Menu.*

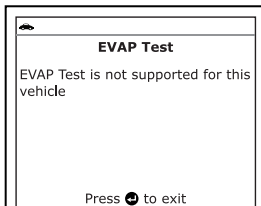

3. When the EVAP leak test has been initiated by the vehicle's on-board computer, a confirmation message shows on the Scan Tool's display. Press the **ENTER** ⏏ button to return to the Main Menu.

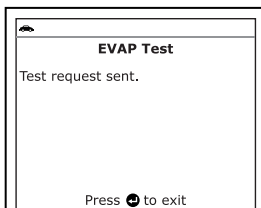

VIEWING MONITOR ICON DESCRIPTIONS

The **I/M MONITOR STATUS** icons on the Scan Tool's LCD display provide an indication of the "Completed / Not Complete" status for all I/M Monitors supported by the vehicle under test. The **Monitor Icons** function displays the full name for each Monitor icon.

1. From the Main Menu, use the **DOWN** ▼ button, as necessary, to highlight **Monitor Icons**, then press the **ENTER** ⏏ button.
 - The Monitor Icon screen displays.
 - The screen shows a list of the 15 Monitor icons, along with the full name for each icon. Use the **DOWN** ▼ button, as necessary, to scroll the list.
2. When you have finished viewing the Monitor icon descriptions, press the **ENTER** ⏏ button to return to the Main Menu.

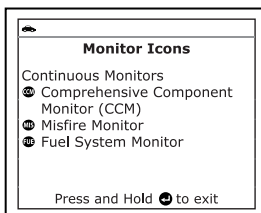
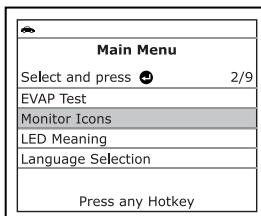

VIEWING THE LED MEANING

The **SYSTEM STATUS** LEDs on the Scan Tool provide a visual indication of the I/M Readiness status of the vehicle under test. The **LED Meaning** function provides a description of the meanings of the green, yellow and red **SYSTEM STATUS** LEDs.

- From the Main Menu, use the **DOWN** ▼ button, as necessary, to highlight **LED Meaning**, then press the **ENTER** ↵ button.
 - The LED Meaning screen displays.
 - The screen provides a description of the meanings of the green, yellow and red **SYSTEM STATUS** LEDs. Use the **DOWN** ▼ button, as necessary, to scroll the display.
- When you have finished viewing the LED meanings, press the **ENTER** ↵ button to return to the Main Menu.

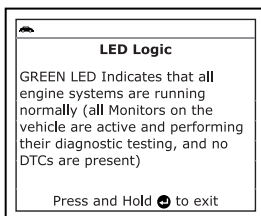
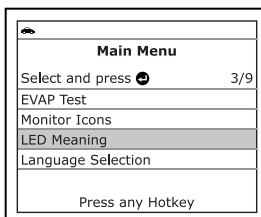

ADJUSTMENTS AND SETTINGS

Selecting the Display Language

- Use the **DOWN** ▼ button, as necessary, to highlight **Language Selection** in the Main Menu, then press the **ENTER** ↵ button.
 - The Select Language screen displays.
 - The currently selected display language is highlighted.
- Use the **DOWN** ▼ button, as necessary, to highlight the desired display language.
- When the desired display language is highlighted, press the **ENTER** ↵ button to save your changes and return to the Main Menu (shown in the selected display language).

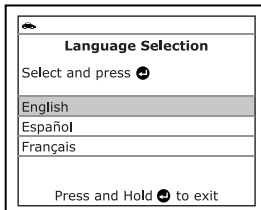
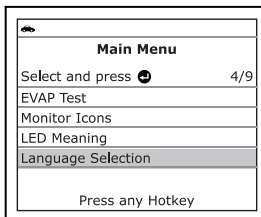

Adjusting Display Brightness

1. Use the **DOWN** ▼ button, as necessary, to highlight **Adjust Brightness** in the Main Menu, then press the **ENTER** ↵ button.
 - The Adjust Brightness screen displays.
 - The **Brightness** field shows the current brightness setting, from 1 to 4.
2. Use the **DOWN** ▼ button, as necessary, to select **Brighter** or **Darker**, as desired, then press the **ENTER** ↵ button.
3. Repeat steps 1 and 2 until the desired display brightness is obtained.

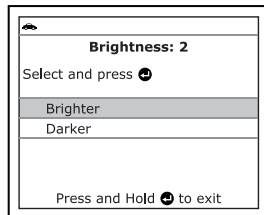
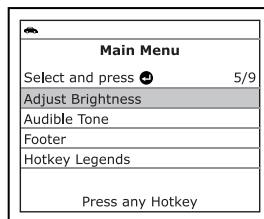

Enabling the Audible Tone

1. Use the **DOWN** ▼ button, as necessary, to highlight **Audible Tone** in the Main Menu, then press the **ENTER** ↵ button.
 - The Audible Tone screen displays.
2. Use the **DOWN** ▼ button, as necessary, to highlight **On** or **Off** as desired.
3. When the desired option is selected, press the **ENTER** ↵ button to save your changes and return to the Main Menu.

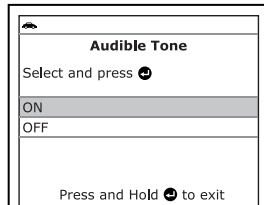
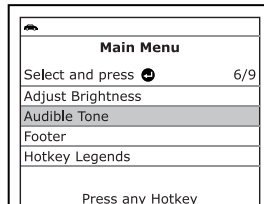

Disabling Navigational Footers



Navigational “footers” are shown at the bottom of most display screens. They show which hotkey to press to return to the topmost menu for the current function.

1. Use the **DOWN** ▼ button, as necessary, to highlight **Footer** in the Main Menu, then press the **ENTER** ↵ button.
 - The Footer screen displays.
2. Use the **DOWN** ▼ button, as necessary, to highlight **On** or **Off** as desired.

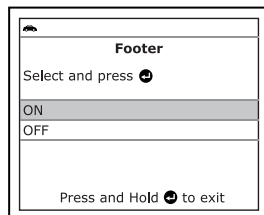
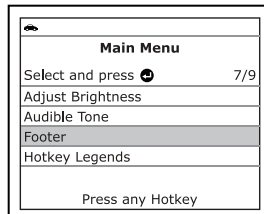

- When the desired option is selected, press the **ENTER** \leftarrow button to save your changes and return to the Main Menu.

Viewing Hotkey Legends

- Use the **DOWN** \blacktriangledown button, as necessary, to highlight **Hotkey Legends** in the Main Menu, then press the **ENTER** \leftarrow button.
 - The Hotkey Legends screen displays.
 - The screen shows a functional description of each of the Scan Tool's hotkeys. Use the **DOWN** \blacktriangledown button, as necessary, to scroll the list.
- When you have finished viewing the Hotkey Legends, press the **ENTER** \leftarrow button to return to the Main Menu.

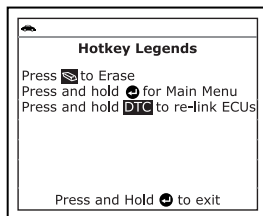
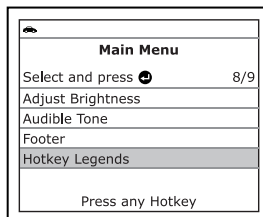

Setting the Unit of Measurement

- Use the **DOWN** \blacktriangledown button, as necessary, to highlight **Unit of Measurement** in the Main Menu, then press the **ENTER** \leftarrow button.
- Use the **DOWN** \blacktriangledown button, as necessary, to highlight the desired unit of measurement.
- When the desired unit of measurement value is selected, press the **ENTER** \leftarrow button to save your changes and return to the Main Menu.

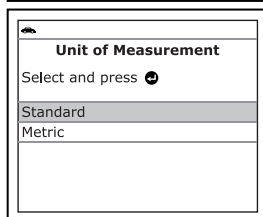
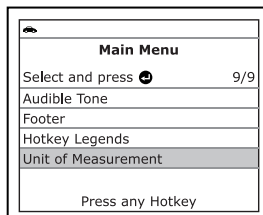

Exiting the MENU Mode

- Press and hold the **ENTER** \leftarrow button to exit the Menu mode.

LIMITED ONE YEAR WARRANTY

The Manufacturer warrants to the original purchaser that this unit is free of defects in materials and workmanship under normal use and maintenance for a period of one (1) year from the date of original purchase.

If the unit fails within the one (1) year period, it will be repaired or replaced, at the Manufacturer's option, at no charge, when returned prepaid to the Service Center with Proof of Purchase. The sales receipt may be used for this purpose. Installation labor is not covered under this warranty. All replacement parts, whether new or remanufactured, assume as their warranty period only the remaining time of this warranty.

This warranty does not apply to damage caused by improper use, accident, abuse, improper voltage, service, fire, flood, lightning, or other acts of God, or if the product was altered or repaired by anyone other than the Manufacturer's Service Center.

The Manufacturer, under no circumstances shall be liable for any consequential damages for breach of any written warranty of this unit. This warranty gives you specific legal rights, and you may also have rights, which vary from state to state. This manual is copyrighted with all rights reserved. No portion of this document may be copied or reproduced by any means without the express written permission of the Manufacturer. **THIS WARRANTY IS NOT TRANSFERABLE.** For service, send via U.P.S. (if possible) prepaid to Manufacturer. Allow 3-4 weeks for service/repair.

SERVICE PROCEDURES

If you have any questions, require technical support or information on UPDATES and OPTIONAL ACCESSORIES, please contact your local store, distributor or the Service Center.

USA & Canada:

(877) 227-7226 (6:00 AM-6:00 PM PST, Monday through Saturday)

All others: (714) 241-6802 (6:00 AM-6:00 PM PST, Monday through Saturday)

FAX: (714) 241-3979 (24 hr.)

Web: www.pro.innova.com



17352 Von Karman Avenue
Irvine, CA 92614

Printed in China MRP #93-1034
Copyright © 2017 IEC. All Rights Reserved.

