

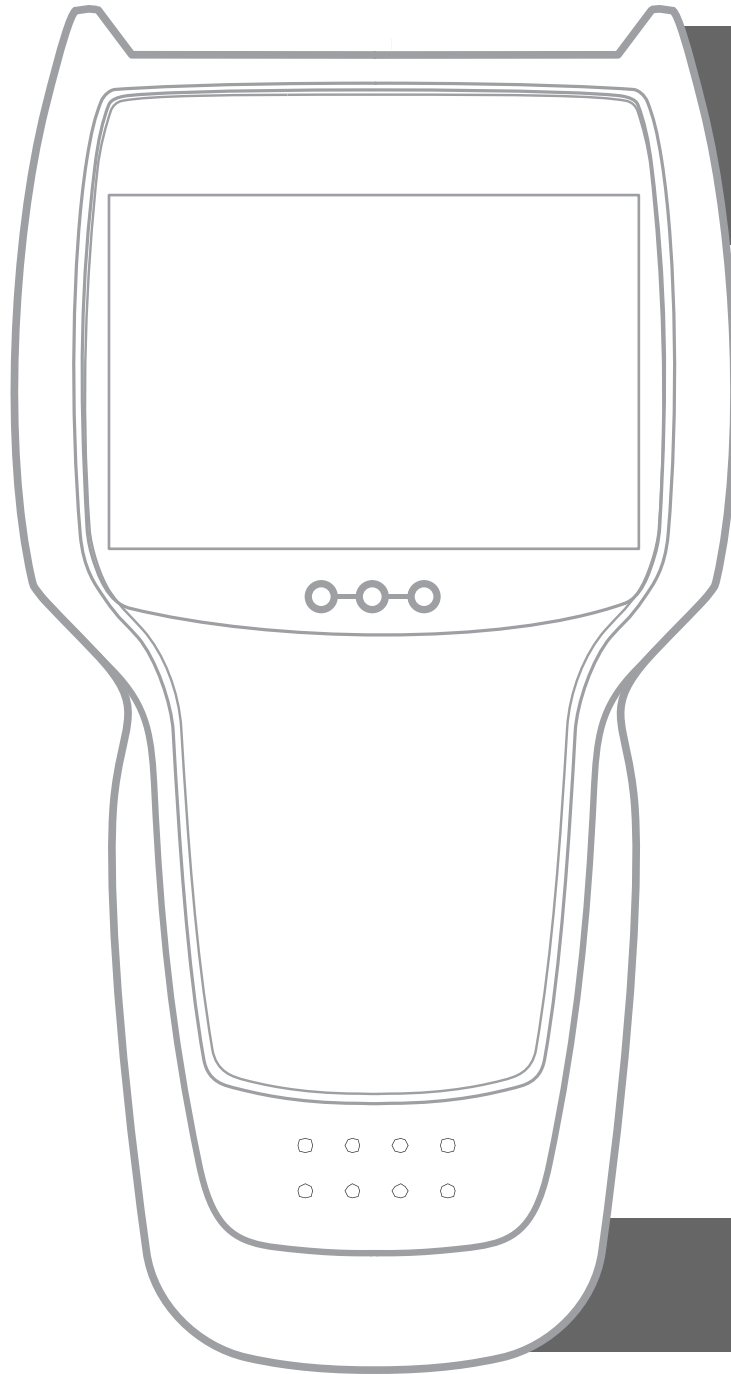

TECHNICAL ASSISTANCE  
**1 800 544 4124**  
HABLAMOS ESPAÑOL • SERVICE IN THE USA  
ASE CERTIFIED TECHNICIANS  
INNOVA.COM



[www.innova.com/manuals](http://www.innova.com/manuals)



# Innova



## QUICK START GUIDE

### RepairSolutions 2

# INNOVA

Innova Electronics Corp.

17352 Von Karman Ave.

Irvine, CA 92614

Instruction MRP #93-1118 rev. a

Copyright © 2019 IEC. All Rights Reserved.





**1**

**RepairSolutions 2**

ANDROID APP ON **Google play** Available on the iPhone **App Store**

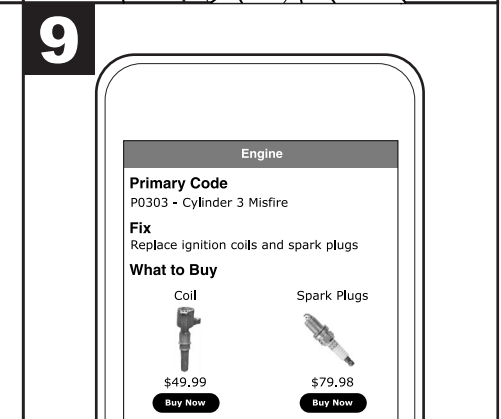
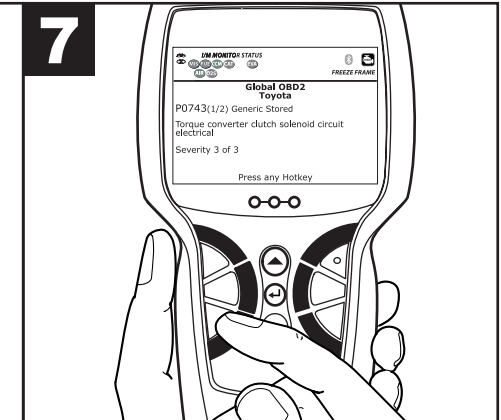
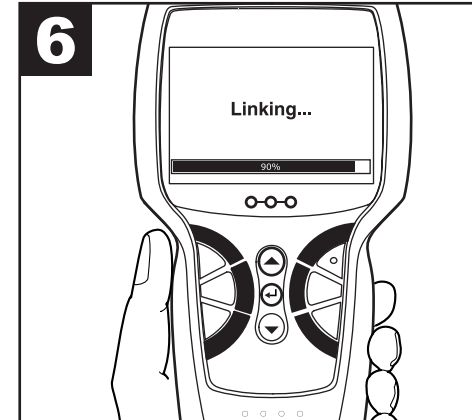
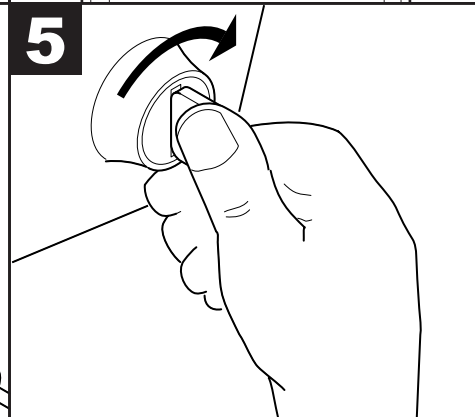
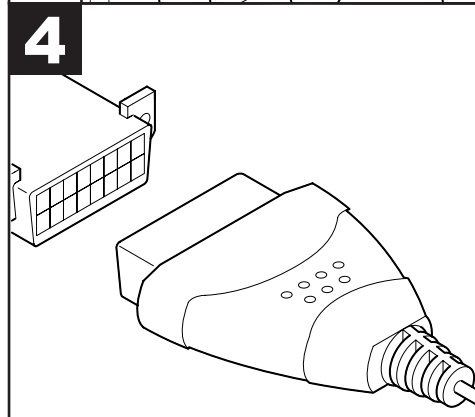
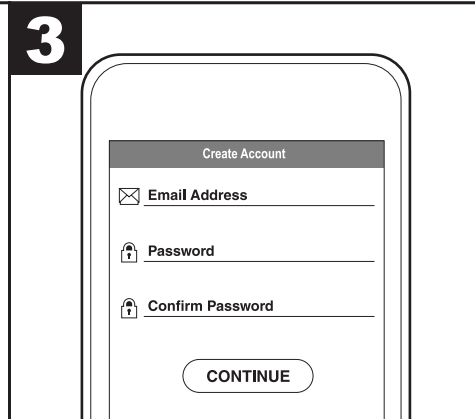
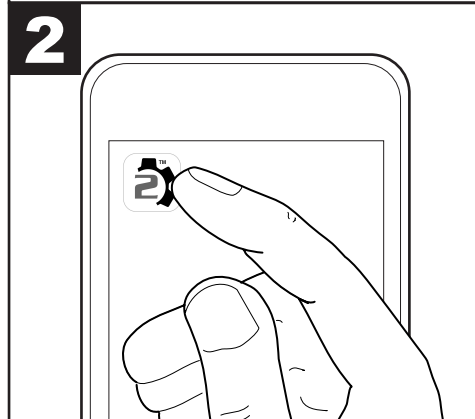

**Note:** If tool is not connected to Wi-Fi or Bluetooth, vehicle data will not be saved.

**Remarque:** Si l'outil n'est pas connecté au Wi-Fi ou à Bluetooth, les données du véhicule ne seront pas enregistrées.

